



FREEMASONRY

AND

The Bible

**Are these
Compatible?**

By Rev. Dr. Izak Labuschagne

2001

TABLE OF CONTENTS

TABLE OF CONTENTS	2
INTRODUCTION OF SPEAKER	5
OVERVIEW.....	6
CHAPTER ONE.....	7
JUDGING FREEMASONRY.....	7
DEFINITION OF FREEMASONRY	7
IS FREEMASONRY FOUNDED ON THE BIBLE?.....	7
<i>Opening understanding / Closing understanding</i>	9
IS FREEMASONRY A SECRET SOCIETY?.....	9
MASONIC OATHS.....	11
ARE THE DETAILS IN THE UPPER DEGREES HIDDEN FROM FREEMASONS OF LOWER DEGREES.....	13
<i>Lower degree Masons are deliberately deceived by those of the upper degrees</i>	13
<i>What is this light really?</i>	13
CHAPTER TWO.....	15
IS FREEMASONRY A RELIGION	15
<i>Definition of religion</i>	15
<i>Masonry even has a way of Salvation</i>	16
<i>The religion of Freemasonry propagates new birth</i>	17
SO THEN WHAT RELIGION IS FREEMASONRY	18
<i>Cabalism</i>	18
<i>Nimrod</i>	19
<i>Sun Worship</i>	19
<i>Meaning of the Masonic God Jahbulon</i>	19
<i>Solomon and Hiram Abif or rather Hiram King of Tyre</i>	20
WHAT IS CABALISM.....	21
WHAT DOES THE BIBLE SAY ABOUT CABALISM.....	22
<i>Overview diagram</i>	22
DANGERS OF CABALISM	22
<i>3rd degree Horus and Isis</i>	23
<i>Curses of the Bible</i>	23
GRADUAL ROAD TO CABALISM	25
SECULAR HUMANISM.....	25
THE DANGERS OF FREEMASONRY	25
<i>MASONIC ILLUMINATION - LUCIFERIAN</i>	26
<i>MASONIC GOD - LUCIFER</i>	27
<i>THE WITCHCRAFT CONNECTION</i>	29
<i>SIMILARITIES BETWEEN FREEMASONRY, THE OCCULT AND SATANISM</i>	30
CHAPTER THREE	34
WHERE DOES MASONRY COME FROM	34

<i>MYSTERY BABYLON</i>	34
<i>The Knights Templar</i>	36
<i>Hospitalers</i>	37
<i>Jesuits Ignatius De layola</i>	37
<i>Jesuit Oath</i>	38
METHOD OF INFILTRATION.....	40
CHAPTER FOUR	43
THE POLITICAL INTERCONNECTIONS	43
<i>The Palladium</i>	43
<i>Illuminati</i>	43
<i>One Dollar Bill</i>	44
TODAY'S NETWORK	46
<i>The Lucis (Lucifer) Trust</i>	46
<i>A New Age Network</i>	46
<i>The Vatican</i>	47
<i>The Club of Rome</i>	49
<i>The Provisional World Government</i>	49
<i>The Tavistock Institute – Workshop</i>	50
<i>The Council on Foreign Relations</i>	50
<i>The Royal Institute of International Affairs</i>	50
<i>The Bilderbergers</i>	50
<i>The Tri Lateral Commission</i>	50
<i>The Mafia Yakuza and Triads</i>	50
<i>Multinationals</i>	50
<i>The Committee of 300</i>	50
<i>The UN</i>	50
<i>Conditionality Treaties</i>	50
<i>The Rio Summit</i>	50
<i>The Iron Mountain Report</i>	50
RELATED ORGANIZATIONS TO FREEMASONRY.....	52
CHAPTER FIVE	53
FREEMASONRY AND LITIGATION	53
<i>Judge President</i>	65
<i>RE: LABUSCHAGNE V D WARNE AND ASSOCIATES (PTY) LTD - CASE NO 5447/96</i> ...	65
<i>Secret Societies and organizations Freemasonry</i>	66
<i>Unethical conduct by officers of court</i>	67
CHAPTER SIX	71
BRAINWASHING TECHNIQUES	71
<i>Training Manual No. TM-SW7905.1</i>	72
MIND CONTROL APOTHEOSIS	77
NOTICES OF COMMISSION	78
CHAPTER SEVEN	79
SUMMARY.....	79
WHAT TO DO IF I AM A CHRISTIAN?	79
COVENANT OATH OF GOD AND OF MAN.....	81
THE ARMOUR OF GOD	82

OTHER POINTS TO CONSIDER ARE: -.....	82
GODS PLAN OF SALVATION	83
<i>The Bible says there is only one way to Heaven</i>	<i>83</i>
MORE SCRIPTURES FOR FREEMASONS.....	86
PRINCIPALITIES AND POWERS	86
OATHS	86
SECRECY	86
LIGHT.....	87
GODS NAME	88
HIRAM ABIF KING OF TYRE (ITHOBALUS 11)	88
BOAZ.....	90
KINSMAN'S REDEMPTION BOAZ	90
CORNER STONE.....	93
<i>Parable of Vinyard _</i>	<i>93</i>
<i>String.....</i>	<i>96</i>
NIMROD	100
SOLOMON	102
DECEPTION	102
WISDOM.....	106
NOT WORKS -GRACE.....	107
SALVATION THROUGH CHRIST ALONE.....	108
BE BORN AGAIN.....	108
LACK OF KNOWLEDGE.....	109
IDOLS - OTHER GODS.....	109
OTHER PRACTICES.....	109
GODS JUDGMENT	110
3 - 4 GENERATIONS	111
BURN IT	111
CHASTISING	111
BE SEPRATED.....	112
GATES OF BRASS	113
DEMIT TO THE LODGE.....	114
BIBLIOGRAPHY.....	116
MASONIC.....	116
NEWSLETTERS	117
VIDEO TAPES	118
NEW WORLD ORDER.....	118
NEWSLETTERS	120
VIDEOS.....	120
INDOCTRINATION TECHNIQUES.....	121
NEWSLETTERS	122
VIDEOS.....	122
NEW AGE SECULAR HUMANISM.....	123
<i>VATICAN</i>	<i>123</i>
CONTACT DETAILS.....	125

INTRODUCTION OF THE AUTHOR

The submission you are about to experience arises from: - **The Commission of Inquiry into Administrative Irregularities in the System of Justice and Activities by Members of Secret Societies.**



The late Judge Hassan Mall of the Truth and Reconciliation Commission granted the abovementioned commission following an application to the High Court of Durban brought in person by Izak Labuschagne in May 1995. The Commission is the first *actio popularis* i.e., **Peoples Commission** under Section 38 of the **New Constitution of South Africa** and Izak currently serves as the **Chief Investigating Officer** of the Commission. Following the activities of the commission and in particular it's interaction with the office of the **President of South Africa**, the **Judicial Services Commission** adopted the practice of *questioning all new judges on their affiliations to secret societies*.

By 1988 Izak was a **Certified Australian Investment Planner**, member of the **International Financial Planners Association** and **advisor for the Bank of New Zealand** in respect of their Cash-link facility and a **licensed as a Dealers Representative** on the **Sydney Stock Exchange**.

Following the activities of the Commission and his winning of several protracted **court cases** (*fought in person*) against the likes of **Anglo American, Standard Bank** and **Portnet** in South Africa and **various Ministries in Swaziland** together with his application to the **Constitutional Court** in what has now become known as *The Bible Case*, Izak was granted an **honorary Doctorate in Ecclesiastical Law** by **Arlington University in Australia**, as such through the **Holy Nation Bible College** in KZN, which college also **ordained** him as Minister of the Gospel of Jesus Christ.

Izak has served as non-affiliated **Guardian Committee Member** and **Legal Advisor** for the **African Christian Democratic Party** and he has **intervened in the public interest** in several prominent political and religious cases in South Africa. Izak has acted as **Strategic Planner** for several projects in the SADEC region reported to the **Australian High Commission** in respect of projects in Swaziland.

Through the Commission Izak has gained a vast knowledge of **secret and not so secret societies, Biblical and Secular law**, together with the *ins and outs of the International Political, Business and Ecclesiastical world*.

In the light of the above, I am sure you will find this submission very stimulating. Should you have any questions, contact details will be made available at the end of this submission. See www.izak.co.za for more of an up-to-date bio. Australians may like to refer to the overview tab on that page. Other publications appear under the publications tab. Latest initiatives are at www.irff.online

OVERVIEW

The purpose of this article is to discover from the Masonic authorities themselves whether Freemasonry is compatible with the Bible or not. The reference material that will be quoted from will comprise only of recognized Masonic authorities, the King James Version of the Bible and such evidence as the Commission obtained.

Most Freemasons are members of what is known as the Blue Lodge, which is made up of the first 3 degrees known as *Entered Apprentice*, *Fellow Craft* and *Master Mason's* degrees respectively. In each of these degrees a blood oath is sworn which binds the candidate from revealing the secret given in that degree at pains of death. Today, many Modern Masonic lodges merely refer to these oaths rather than relate the full version during ritual. Most Masons do not embark on the rest of the degrees, known as side degrees and therefore never find out all there is to be known about Freemasonry.

This publication will cast some light on what happens in the other degrees and orders and no doubt this will enable some Blue Lodge members to make a proper assessment of where they might want Masonry to take them. As I am not a Mason, I am at liberty to divulge this information and Masons are at liberty to receive it from me. Masons however are not at liberty to divulge certain information to members of lower degrees or to non-members (referred to as *the profane* by Masons).

As Chief Investigating officer of the Commission I have had access to all the relevant Masonic material found in Masonic libraries. I have a detailed knowledge of all the important degrees, including the hidden esoteric degrees. Ritual and degrees of various orders such as the Ancient Arabic Order of the Noble Shrine, the Ordo Templi Orientis and the like was also obtained. In addition, I have had access to the rituals and degrees of various other organizations such as the Rosicrucian's, Swedenborgians, Templars, Thiel Society, Vrill Society, the Black Nobility of Europe, the Jesuits and the Merovingians.

Information on the most modern organizations such as the Bilderbergers, Committee of 300 and others was also obtained. Most importantly the interconnections or not of the various organizations were also identified. As a result, a good overall picture of where the world has emerged from and where it is going was obtained. For this I am thankful. But most of all I am thankful to the Bible because in it I found straight forward and simple answers, explanations and solutions to the many riddles that necessarily arise in this kind of research.

CHAPTER ONE

Judging Freemasonry

Francis G. Paul, 33rd degree Sovereign Grand Commander of freemasonry wrote in 'The Northern Light,' of May 1988, a prominent newsletter of Freemasonry in the USA: -

"As a fraternity, we are always ready to be judged - severely and critically"

I do not intend to judge Freemasons. I believe I am restrained doing so by my Christian beliefs. What I do intend to do however, is to present the evidence as it is contained in Masonic Authorities and the Hold Bible. From this I will draw what are logical and quite obvious conclusions. From this you, the reader must judge for yourself. You must then make your own decisions. I pray that you will make the right ones.

Definition of Freemasonry

Freemasonry is defined as: -

"A peculiar system of morality, veiled in allegory and illustrated by symbols"

Is Freemasonry founded on the Bible?

In addressing this comparative study, the first question one needs to ask is whether the Freemasonry has anything to do with the Bible.

In the indisputable authority of *Freemasonry Morals and Dogma of the Ancient and Accepted Scottish Rite of Freemasonry* (Morals and Dogma) by the Grand Sovereign Pontiff of Freemasonry and author of the 33 degrees of Scottish Freemasonry ex – Confederate General, Albert Pike on page 11 of that authority we read: -



The Holy Bible, square and compass are not only styled the Great Lights in Masonry, but they are technically called the "Furniture of the Lodge" ... The Bible is an indispensable part of the furniture of a Christian Lodge, only because it is a sacred book of Christian religion... The obligation (oath) of the candidate is always to be taken on the sacred book....

In the digest of Masonic Law pp 207-209 we find this statement on the subject: -

Masonry has nothing whatsoever to do with the Bible, that it is not founded on the Bible, for if it were, it would not be Masonry, it would be something else.

The Kentucky Monitor in dealing with the Fellow craft Degree stated on page 95

Masonry makes no profession of Christianity ... but looks forward to the time when the labour of our ancient brethren shall be symbolized by the erection of the spiritual temple... in which there shall be one altar and one worship; one common altar of Masonry on which the Veda, Shastra, the Persian, The Assyrian, the Chaldean, the Egyptian, the Chinese, the Mohammedan, the Jew and the Christian may kneel.



Joseph Fort Newton wrote in his book 'The Builders on page 223: -

"Where else, except in a Masonic lodge, could men of many religions meet, each praying for all and all for each one?"

*"Masonry...**is religion**, a worship in which all good men may unite, that each may share the faith of all"*

What does the Bible say about itself

*II Timothy 3:16 **All scripture [is] given by inspiration of God**, and [is] profitable for doctrine, for reproof, for correction, for instruction in righteousness:*

Revelation 22:18 For I testify unto every man that heareth the words of the prophecy of this book. If any man shall add unto these things, God shall add unto him the plagues that are written in this book:

Revelation 22:19 And if any man shall take away from the words of the book of this prophecy, God shall take away his part out of the book of life, and out of the holy city, and [from] the things which are written in this book.

*Deuteronomy 27:26 **Cursed [be] he that confirmeth not [all] the words of this law** to do them. And all the people shall say, Amen.*

Deuteronomy 28:16 Cursed [shalt] thou [be] in the city, and cursed [shalt] thou [be] in the field.

Deuteronomy 28:17 Cursed [shall be] thy basket and thy store.

Deuteronomy 28:18 Cursed [shall be] the fruit of thy body, and the fruit of thy land, the increase of thy kine, and the flocks of thy sheep.

Deuteronomy 28:19 Cursed [shalt] thou [be] when thou comest in, and cursed [shalt] thou [be] when thou goest out.

*Hosea 4:6 My people are destroyed for **lack of knowledge**: because thou hast rejected knowledge, I will also reject thee, that thou **shalt be no priest to me**: seeing thou hast **forgotten the law of thy God**, I will also **forget thy children**.*

Opening understanding / Closing understanding

*II Thessalonians 2:11 **And for this cause God shall send them strong delusion, that they should believe a lie:***

*II Thessalonians 2:12 **That they all might be damned who believed not the truth, but had pleasure in unrighteousness.***

*II Timothy 4:2 **Preach the word; be instant in season, out of season; reprove, rebuke, exhort with all longsuffering and doctrine.***

*II Timothy 4:3 **For the time will come when they will not endure sound doctrine; but after their own lusts shall they heap to themselves teachers, having itching ears;***

*II Timothy 4:4 **And they shall turn away [their] ears from the truth, and shall be turned unto fables.***

*II Timothy 4:5 **But watch thou in all things, endure afflictions, do the work of an evangelist, make full proof of thy ministry.***

Is Freemasonry a Secret society?

Freemasonry is not a secret organization, as everyone knows about it. It is however an organization which purports to hold certain secrets. These secrets are revealed to members only and as such in ceremonies and rituals making up some 33 degrees in Scottish Freemasonry, 9 Knighthoods in English Freemasonry another 66 odd degrees in Esoteric Freemasonry various orders in what used to be called the triangle lodges of the Trapezium, the Trapezoid and the Illuminati.

Albert Pike in *Morals and Dogma* in dealing with the 4th degree on page 109 states: -

Secrecy is indispensable in a Mason of whatever degree

Albert Mackey in his *Textbook on Masonic Jurisprudence* under the 23rd landmark – secrecy states:

*The secrecy of this institution is another and most important landmark... **If divested of its secret character, it would lose its identity, and would cease to be Freemasonry... death of the Order would follow its legalized exposure. Freemasonry, as a secret association has lived unchanged for centuries; as an open society it would not last for many years***

What does Bible say about secrecy

Mark 4:22 For **there is nothing hid, which shall not be manifested; neither was anything kept secret, but that it should come abroad.**

Luke 8:17 For nothing is secret, that shall not be made manifest; neither [anything] hid, that shall not be known and come abroad.

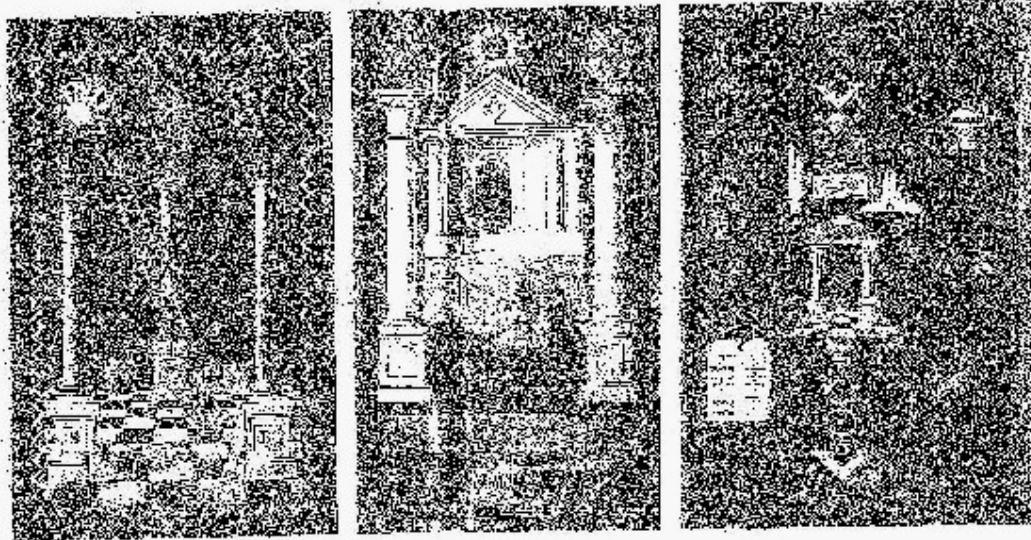

*re is] no man [that] doeth anything in secret,
And he himself seeketh to be known openly. If thou do these
things, shew thyself to the world.*

John 18:20 Jesus answered him, I spake openly to the world; I ever taught in the synagogue, and in the temple, whither the Jews always resort; and in secret have I said nothing.

Ephesians 5:12 For it is a shame even to speak of those things which are done of them in secret.

Isaiah 29:15 Woe unto them that seek deep to hide their counsel from the LORD, and their works are in the dark, and they say, Who seeth us? and who knoweth us?

John 8:12 Then spake **Jesus** again unto them, saying, **I am the light of the world:** he that followeth me shall not walk in darkness, but shall have the light of life.

Ephesians 5:14 Wherefore he saith, awake thou that sleepest, and arise from the dead, and **Christ shall give thee light.**

Masonic Oaths

The Fellowcraft Freemason¹ swears at his "raising" to Master Mason Status:

"I will obey all regular signs, summonses, or tokens, given, handed, sent, or thrown to me from the hand of a brother Master Mason"²

and

"A Master Mason's secrets, given to me in charge as such, and I knowing them to be such, shall remain as secure and inviolable in my breast as in his own, when communicated to me, murder and treason excepted, and they left to my own election."

In the Royal Arch Degree³ the candidate swears that

"I furthermore Promise and Swear that I will keep all secrets of a companion Royal Arch Mason when communicated to me as such, or I knowing them to be such, without exceptions. I will aid and assist a companion Royal Arch Mason when engaged in any difficulty; and espouse his cause so far as to extricate him from same, if in my power, whether he be right or wrong"

In the current handbooks for Freemasons⁴ the oaths are even more explicit in that the Master Mason is tasked to:

'travel through dangers and difficulties to unite with his in forming a column of mutual defense and support.' and 'I solemnly swear to observe without evasion, equivocation, or mental reservation of any kind under no less a penalty that of having my body severed in twain, my bowels taken from thence and burned to ashes, the ashes scattered to the four winds of heaven, so that no more trace or remembrance may be had of so vile and perjured a wretch as I, should I ever knowingly or willingly violate this my solemn obligation as a master mason. So, help me God, and keep me steadfast in the due performance of same.'



In the Masonic Handbook page 183 to 184 we read that:

"Whenever you see the grand hailing sign... be sure not to bring the Mason guilty if you cheat or wrong any other, the government even, Masonry cannot

¹ 2nd degree, the first being "the Entered Apprentice" the third being the Master Mason. Most Masons take the first 3 degrees (called "the Blue Lodge")

² quoted from "Freemasonry" By Rev C. Finney page 44

³ Side degree to Master (18th) possessed by Most senior Masons *ibid.* Finney Page 142 to 145

⁴ "The Scottish Workings of Craft Masonry" 1982 edition and "The Complete Workings of and Craft Freemasonry" published by A Lewis (Masonic Publishers) Ltd., Surrey, Available through 'Masonic Suppliers' in Durban

and will not touch you... Conceal the crimes of your brother Masons. Shield him. Prevaricate, don't tell the whole truth in this case, keep his secrets, forget the most important points. It may be perjury to do this, it is true, but you're keeping your obligations, and remember if you live up to your obligation strictly, you'll be free from sin"

Masons are sworn to persecute unto death anyone who violates Masonic obligation. In the oath of the *THRICE ILLUSTRIOUS OF THE CROSS*⁵, the candidate swears, as follows:

*"You further swear, that should you know another to violate any essential point of this obligation, you will use your most decided endeavors, by the blessing of God, to bring such person to the strictest and most condign punishment, agreeable to the rules and usages of our ancient fraternity; and this, **by the pointing him out to the world as an unworthy vagabond, by opposing his interests, by deranging his business, by transferring his character after him wherever he may go, and by exposing him to the contempt of the whole fraternity and of the world, during his whole natural life.**"*

From page 184 of the Masonic Handbook, we read: -

Whether you swear of take God's name in vain don't matter so much. Of course, the name of the Lord Jesus Christ, as you know, don't amount to anything, but Mah-hah-bone – O, horror! You must never, on any account, speak that awful name aloud. That would be the most heinous crime – unmasonic – unpardonable.

What does the Bible say about Oaths

*Matthew 5:34 But I say unto you, **swear not at all**; neither by heaven; for it is God's throne:*

Matthew 5:35 Nor by the earth; for it is his footstool: neither by Jerusalem; for it is the city of the great King.

Matthew 5:36 Neither shalt thou swear by thy head, because thou canst not make one hair white or black.

*Matthew 5:37 **But let your communication be, Yea, yea; Nay, nay: for whatsoever is more than these cometh of evil.***

Matthew 23:16 Woe unto you, [ye] blind guides, which say, whosoever shall swear by the temple, it is nothing; but whosoever shall swear by the gold of the temple, he is a debtor!

⁵ "Light on" eighth edition, page 199: as quoted in "The Character, and Practical Workings of Freemasonry" by Rev. C.G. Finney pages 102, 103 and 106

Matthew 23:18 And, whosoever shall swear by the altar, it is nothing; but whosoever sweareth by the gift that is upon it, he is guilty.

*James 5:12 But above all things, my brethren, **swear not**, neither by heaven, neither by the earth, neither by any other oath: but let your yea be yea; and [your] nay, nay; lest ye fall into condemnation.*

Are the details in the upper degrees hidden from Freemasons of lower degrees

Lower degree Masons are deliberately deceived by those of the upper degrees

Freemasons should know that they are deliberately deceived, it seems even brainwashed.

Albert Pike in his book 'Morals and Dogma'⁶ on page 819 states: -

"The Blue degrees are but the outer court or porticles of the temple part of the symbols are displayed there to the initiate but he is intentionally misled by false interpretations. It is not intended that he shall understand them but that he shall imagine that he shall understand them."

Grand Commander Henry C Clausen 33rd degree also admits: -

"It must be apparent that the blue Lodge... degrees cannot explain the whole of Masonry. They are the foundation.... An initiate may imagine he understands the ethics, symbols and enigmas, whereas the true explanation of these is reserved for the more adept."

Albert Pike in 'Morals and Dogma' page 104-105

"Masonry like all the religions, Hermeticism and Alchemy, conceals its secrets from all except the Adepts and Sages, or the Elect, and uses false explanations and misinterpretations of its symbols to mislead those who deserve only to be misled; to conceal the truth which it calls light, from them, and to draw them away from it."

What is this light really?

According to Pike on page 321 of *Morals and Dogma*: -

"Lucifer the light bearer! ...Lucifer, the Son of the Morning! It is he who bears the light... Doubt it not!"

Albert Pike's instructions to the "Sovereign Grand Inspectors General of the world are: -

⁶ *Morals and Dogma of the Ancient and Accepted Scottish Rite of Freemasonry* written by The Sovereign Grand Pontiff General of Freemasonry, ex confederate General, Albert Pike who also wrote the 33 degrees of Scottish Rite Freemasonry - the undisputed and ultimate authority of Masonry.

'To you Sovereign Grand Inspectors General we say this, that you may repeat it to the brethren of the 32nd, 31st. and 30th degrees:

*'The Masonic religion should by all of us initiates of the high degrees, be maintained in the purity of **Luciferian doctrine**'*

What does the Bible say about light

Isaiah 8:19 And when they shall say unto you, seek unto them that have familiar spirits, and unto wizards that peep, and that mutter: should not a people seek unto their God? for the living to the dead?

Isaiah 8:20 To the law and to the testimony: if they speak not according to this word, [it is] because [there is] no light in them.

*John 8:12 Then spake **Jesus** again unto them, saying, **I am the light of the world**: he that followeth me shall not walk in darkness, but shall have the light of life.*

*Ephesians 5:14 Wherefore he saith, awake thou that sleepest, and arise from the dead, and **Christ shall give thee light**.*

*II Corinthians 4:6 For God, who commanded the light to shine out of darkness, hath shined in our hearts, to [give] **the light of the knowledge of the glory of God in the face of Jesus Christ**.*

*II Corinthians 11:14 And no marvel; for **Satan himself is transformed into an angel of light**.*

*Acts 26:18 **To open their eyes, [and] to turn [them] from darkness to light, and [from] the power of Satan unto God, that they may receive forgiveness of sins, and inheritance among them which are sanctified by faith that is in me.***



CHAPTER TWO

Is Freemasonry a religion

Most Masons will vehemently deny that Masonry is a religion.

Mr. Bill Mankin a 32nd degree Mason stated on the John Ankerberg show, which is a popular TV show in the USA: -

"Masonry is not a religion, it has no system of salvation, no creed, no confession of faith, no theology, no symbols as in church"

In 'The Lost Keys of Freemasonry' on pg. 64-65 we read

"The true Mason is not creed bound. He realises with the divine illumination of his lodge that as a Mason his religion must be universal, Christ Buddha or Mohammed, the name means little. For he recognizes only the light and not the light bearer. He worships at every shrine, bows before every alter whether in Temple, Mosque, Pagoda, Cathedral and realises with his true understanding, the oneness of all spiritual truths. No true Mason can be narrow for his lodge is the divine expression of all broadness"

According to 33rd degree Grand Commander and indisputable of Freemasonry, Albert Pike in his book 'Morals ' pg. 575: -

"It" (Masonry) "reverences all the great reformers. It sees in Moses, the lawgiver of the Jews, in Confucius and Zoroaster, in Jesus of Nazareth, and in Arabian Iconoclasts, great teachers of morality and eminent reformers if no more."

Definition of religion

According to the Webster's New World Dictionary the definition of religion is a: -

1. ***"belief in a divine or superhuman power...to be obeyed and worshipped as the creator and ruler of the universe"***
- 2 ***"expression of. (this) belief in conduct and ritual."***

Albert Mackey, another indisputable authority on Freemasonry in 'Revised Encyclopedia of Freemasonry', in quoting Webster's says: -

"Now it is plain that in either of the first three senses in which we take the word religion, **Freemasonry may rightfully claim to be called a religious institution.**"

Henry Wilson Coils in his 'Coils Masonic Encyclopedia' states: -

"Freemasonry certainly requires a belief in the existence of, and man's dependence upon a Supreme being to whom he is responsible. What can a

church add to that except to bring into fellowship those who have like feelings?
That is exactly what the lodge does.

*"Freemasonry has a religious service to commit the body of a deceased brother to the dust whence it came and to speed the liberated spirit back to the great source of light. Many Freemasons make this flight with no other guarantee of a safe landing than their belief in **the religion of Freemasonry**. If that is false hope, the fraternity should abandon funeral services and devote its attention to activities where it is sure of its ground and its authority."*

"The difference between a lodge and a church is one of degree only."

"Nothing herein is intended to be an argument that Freemasonry ought to be religion; our purpose is simply to determine what it has become and is."

Mr. Bill Mankin a 32nd degree Mason stated on the John Ankerberg show.

*"The authoritative source for Masonry is the **ritual**. The ritual - what happens in the lodge, what goes on."*

According to The Grand Lodge of the State of Maitland: -

*"Thus, Masonry is a great fellowship of men of all countries and ages who are capable of discovering in the religious teachings of all humanity, some of them crude indeed, a fundamental truth common to them all, - that God is the father of all mankind and all men are brethren, - that this principle is worth dying for and that he who remains steadfast in the service of this ideal may well hope for and **expect immortal life.**"*

Masonry even has a way of Salvation

Salvation according to the Masonic religion is based on good morals. According to the 'Masonic Monitor' page 54: -

*"The **all-seeing eye** pervades the inmost recesses of the human heart and **will reward us according to our morals** "*

In the 19th degree of the Scottish Rite of Freemasonry: -

*"**Masons who have given proof of the statutes and rules of the order, which in the end will make them deserving of entering the celestial Jerusalem (heaven)**"*

In the 28th degree: -

*"**The true Mason raise himself by degrees until he reaches heaven.**"*

The religion of Freemasonry propagates new birth

Alan Roberts in his book 'The Craft and Its Symbols' states: -

*"You have entered a new world. Symbolically you have been **re-reborn**. This started the moment you became a Freemason. As you process in Masonic knowledge your vision will broaden. You will become more vitally alive than ever before. You will become more aware of your fellow man, your family your church, and your country. Your whole philosophy of life will become richer. This will take place but only if you become Masonically educated.*

From Albert Mackey's 'The Manual of Lodge' pg. 20

*"There he stands without our portals on the threshold of his new Masonic life, in darkness, helplessness and ignorance having been wandering amid the errors and covered over with the pollution of the outer and profane world he comes inquiringly to our door seeking **the new birth** and asking a withdrawal of the veil which conceals divine truth from his uninitiated eyes.*

Salvation dependent on enduring till the end

In the 3rd degree whilst the candidate is led around the alter the lodge, he is told that he will travel: -

*"a rough and dangerous road as a test to your fidelity, perhaps even murdered for keeping the secret. **"He that endureth to the end the same shall be saved."***

From the Masonic Funeral ceremony: -

"Masonry seeks constantly to build the temple of the soul and thus to fit us for the house not made with hands eternal in the heavens."

*"When our brother laboured with us in Masonic attire, he wore a white apron which it was taught is an emblem of innocence and a badge of a Mason. By it he was constantly reminded of that **purity of life and that rectitude of conduct** is necessary to his **gaining admission to the celestial lodge above**"*

In Webb's Monitor p 231 under the word "Chaplain" we read:

*The **Master of the Lodge is a priest**, and director of its religious ceremonies. His duty is to select Scriptures, prayers, etc. and he should be present at the burial of the dead.*

Again, Dr Mackey in his "Manual of the Lodge" p 40 says: -

As Masons we are taught never to commence any great important undertaking without first invoking the blessing and protection of deity, and this is because masonry is a religious institution.

Dr Albert Mackey in his "Textbook of Masonic Jurisprudence" p 95 says-

Masonry is undoubtedly a religious institution

Therefore, Masonry has a distinct creed and dogma, its members to confess belief in a supreme being, without which one be admitted to the lodge. Prayers are said to deity. are sworn in rituals. They even have a funeral service. Office bearers have names such as 'The Senior Deacon. The leader of their ceremonies is referred to as 'Worshipfull Master'

I have dealt at some length with this issue primarily because I have found that Freemasons resolutely try, in the face of even own authorities, to dispute that they are a religion.

So then what Religion is Freemasonry

Cabalism

According to Freemasonry's prince Adept Albert Pike in his book "Morals and Dogma of the Ancient and Accepted Scottish Rite of Freemasonry" in dealing with the 28th degree on page 741 he says: -

Masonry is a search after light. That search leads us directly back, as you see, to Kabbalah (Jewish Book of Magic). In that ancient and little understood medley of absurdity and philosophy, the Initiate will find the source of many doctrines; and may in time come to understand the hermetic philosophers, the Alchemist, all the Anti papal thinkers of the Middle Ages, and Emanuel Swedenborg.

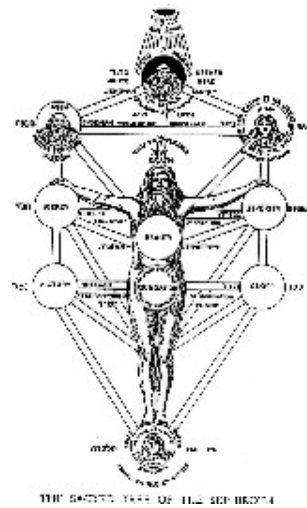

Pike states further on page 744 that

All truly dogmatic religions have issued from the Kabbalah and return to it; everything scientific and grand in the religious dreams of the Illuminati, Jacob Boeheme, Swedenborg, Saint Martin, and others is borrowed from the Kabballah: all the Masonic associations owe to it their secrets and symbols.

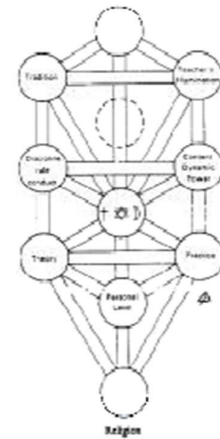

Albert Pike on dealing with the Fellow Craft degree on page 22 says:

Masonry, successor to the Mysteries (the pagan religions of Osiris, Mythras, Tammuz etc.), still follows the ancient manner of teaching.

*Though **Masonry is identical with the ancient Mysteries**, it is only in this qualified sense: that it presents but an imperfect image of their brilliancy, the ruins of their grandeur.*

Dr. J D Buck in his Masonic book and Authority Mystic Masonry on page 119, 140 says: -

Drop the theological barbacles from the religion of Jesus, as taught by Him, and by the Essenes and Gnostics of the first centuries, and it becomes Masonry, Masonry in its purity, derived as it is from the Old Hebrew kabbala as a part of the great universal religion of the remotest antiquity.

Nimrod

Albert On Pg 601 of the Encyclopedia of Freemasonry by A.G. Mackey. Mc Clure Publishing Co., Philadelphia, it says that:

*'The legend of the 'craft' in the old constitutions refers to **Nimrod** as one of the founders of Masonry.'* Mackey pg. 353
'Symbolism of Freemasonry'



Sun Worship

According to Manly P Hall another acclaimed authority on

The point within the circle is derived from sun worship and is in reality of phallic origin. It is a symbol of the universe the sun being represented by a point while the circumference is the universe

From Albert Pike's Morals and Dogma

The sun and moon represent the two grand principals of all generations the active and passive the male and female both shed their light upon their offspring the blazing star or Horus.

Meaning of the Masonic God Jahbulon.

In the Royal Arch degree of the York Rite the candidate is that the secret lost name of God is Jahbulon. The origin of this name however is not immediately taught to candidate:

-

'Jah'- is the Greek work word for 'Jehovah',

'bul'- is a rendering of the name Baal

'on'- is the name used in Babylonian Mysteries to call upon the name of the evil Egyptian deity, Osiris or Horus the son of Isis.

Isis and Horus are the Egyptian equivalent of Semiramis and Tammuz of Babylon, Ahshtarte and Aphrodite, Isi and Iswara of ----- , Cybelle and Deoius of Asia,

What does the Bible say about Nimrod

*Genesis 10:8 And **Cush** begat **Nimrod**: he began to be a mighty one in the earth.*

Genesis 10:9 He was a mighty hunter before the LORD: wherefore it is said, Even as Nimrod the mighty hunter before the LORD.

*Micah 5:6 And they shall waste the land of **Assyria** with the sword, and the land of **Nimrod** in the entrances thereof: thus, shall he deliver [us] from the Assyrian, when he cometh into our land, and when he treadeth within our borders.*

Solomon and Hiram Abiff or rather Hiram King of Tyre

Most Masons will tell you that Solomon features prominently in Masonry as does Hiram Abiff who built the temple of God and held all the secrets of Masonry.

What the Bible says about Solomon and Hiram

*1 Kings 5:1 And **Hiram king of Tyre** sent his servants unto Solomon; for he had heard that they had anointed him king in the room of his father: for Hiram was ever a lover of David.*

*Ezekiel 28:12 Son of man, take up a **lamentation upon the king of Tyrus**, and say unto him. Thus, saith the Lord GOD; Thou sealest up the sum, full of wisdom, and perfect in beauty.*

Ezekiel 28:13 Thou hast been in Eden the garden of God; every precious stone [was] thy covering, the sardius, topaz, and the diamond, the beryl, the onyx, and the jasper, the sapphire, the emerald, and the carbuncle, and gold: the workmanship of thy tabrets and of thy pipes was prepared in thee in the day that thou wast created.

Ezekiel 28:14 Thou [art] the anointed cherub that covereth; and I have set thee [so]: thou wast upon the holy mountain of God; thou hast walked up and down in the midst of the stones of fire.

Ezekiel 28:15 Thou [wast] perfect in thy ways from the day that thou wast created, till iniquity was found in thee.

Ezekiel 28:16 By the multitude of thy merchandise they have filled the midst of thee with violence, and thou hast sinned: therefore I will cast thee as profane out of the mountain of God: and I will destroy thee, O covering cherub, from the midst of the stones of fire.

Ezekiel 28:17 Thine heart was lifted up because of thy beauty, thou hast corrupted thy wisdom by reason of thy brightness: I will cast thee to the ground, I will lay thee before kings, that they may behold thee.

Ezekiel 28:18 Thou hast defiled thy sanctuaries by the multitude of thine iniquities, by the iniquity of thy traffic; therefore will I bring forth a fire from the midst of thee, it shall devour thee, and I will bring thee to ashes upon the earth in the sight of all them that behold thee.

Ezekiel 28:19 All they that know thee among the people shall be astonished at thee: thou shalt be a terror, and never [shalt] thou [be] any more.

*Isaiah 23:1 The **burden of Tyre**. Howl, ye ships of Tarshish; for it is laid waste, so that there is no house, no entering in: from the land of Chittim it is revealed to them.*

*I Kings 11:5 For **Solomon** went after Ashtoreth the goddess of the Zidonians, and after Milcom the abomination of the Ammonites.*

I Kings 11:6 And Solomon did evil in the sight of the LORD, and went not fully after the LORD, as [did] David his father.

*I Kings 11:7 Then did **Solomon** build an high place for Chemosh, the abomination of Moab, in the hill that [is] before Jerusalem, and for **Molech**, the abomination of the children of Ammon.*

I Kings 11:8 And likewise did he for all his strange wives, which burnt incense and sacrificed unto their gods.

*I Kings 11:9 And **the LORD was angry with Solomon**, because his heart was turned from the LORD God of Israel, which had appeared unto him twice,*

I Kings 11:10 And had commanded him concerning this thing, that he should not go after other gods: but he kept not that which the LORD commanded.

*I Kings 11:11 Wherefore the LORD said unto Solomon, forasmuch as this is done of thee, and thou hast not kept my covenant and my statutes, which I have commanded thee, **I will surely rend the kingdom from thee**, and will give it to thy servant.*

What is Cabalism

From 'An Encyclopedia of Religion' by Vergilius Ferm page 420 under Kabbalah on page 412 we read: -

Heb. 'Kabel' - to receive, hence tradition, the esoteric mystical lore of Judaism based upon occult interpretation of the Bible and handed down as secret doctrine to the initiated From Babylonia the centre of Kabbalah moved in the ninth and tenth centuries, to Italy, Spain, the Provence and Germany. To this period belong the Kabbalistic classics... 'Sefer ha-Bahir' (the Luminous Book)the very epitome of Jewish mysticism was the Zohar The central themes of Kabbalah are the nature of the deity - the 'En sof' (the limitless one)Kabbalah employed a

characteristic exegetical technique which gave it great freedom and scope Thus the bible was interpreted not only literally, allegorically, homiletically and anagogically, but also through the devices of the Gematria (the interpretation of the word according to the numerical value of its letters), Notarikon (taking each letter of a word as the initial of some other word), Temurah (substituting one letter for another) and Tziruf or Chiluf (transposing the letters -anagram). Thus, the Kabbalah never felt the constraint of the 'letter which killeth'.

The results of this are described under Zohar on page 842

"The body of the Zohar is interspersed and supplemented with special tracts and dissertations which together form an unsystematic and frequently contradictory compendium of Jewish mystic lore."

What does the Bible say about Cabalism

Judges 8:33 And it came to pass, as soon as Gideon was dead, that the children of Israel turned again, and went a whoring after Baalim, and made **Baal-berith** their god.

Leviticus 20:3 And I will set my face against that man, and will cut him off from among his people; because he hath given of his seed unto **Molech**, to defile my sanctuary, and to profane my holy name.

Overview diagram

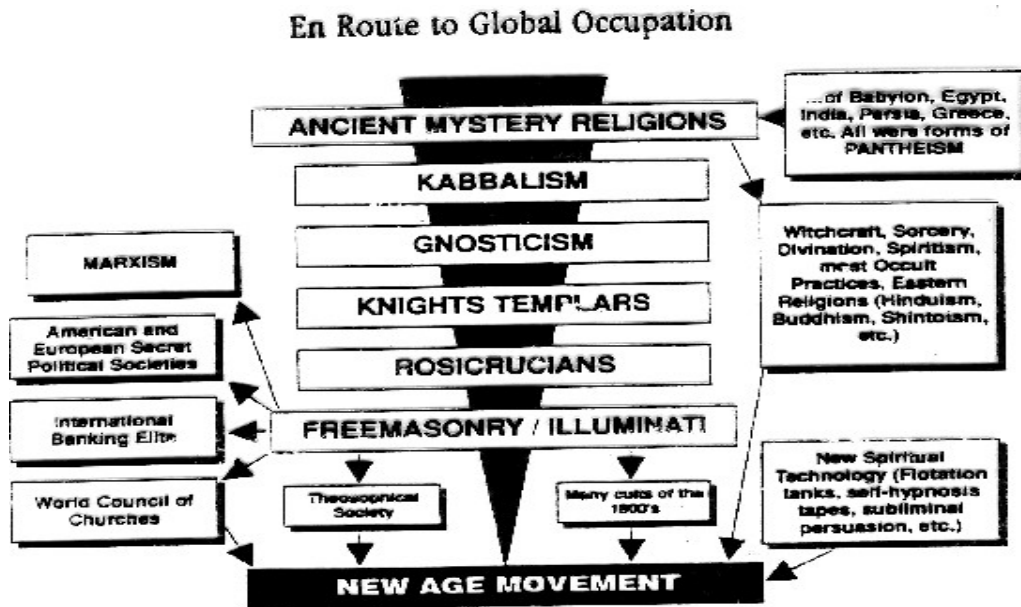

Dangers of Cabalism

3rd degree Horus and Isis

Curses of the Bible

Deuteronomy 18:9 **When thou art come into the land which the LORD thy God giveth thee, thou shalt not learn to do after the abominations of those nations.**

Deuteronomy 18:10 There shall not be found among you [any one] that maketh his son or his daughter to pass through the fire, [or] that useth divination, [or] an observer of times, or an enchanter, or a witch,

Deuteronomy 18:11 Or a charmer, or a consulter with familiar spirits, or a wizard, or a necromancer.

Deuteronomy 18:12 For all that do these things [are] an abomination unto the LORD: and because of these abominations the LORD thy God doth drive them out from before thee.

Exodus 20:3 Thou shalt have no other gods before me.

Exodus 20:4 Thou shalt not make unto thee any graven image, or any likeness [of anything] that [is] in heaven above, or that [is] in the earth beneath, or that [is] in the water under the earth:

Exodus 20:5 Thou shalt not bow down thyself to them, nor serve them: for I the LORD thy God [am] a jealous God, visiting the iniquity of the fathers upon the children unto the third and fourth [generation] of them that hate me;

Ezekiel 8:8 Then said he unto me, Son of man, dig now in the wall: and when I had **digged in the wall**, behold a door.

Ezekiel 8:9 And he said unto me, Go in, and behold the **wicked abominations** that they do here.

Ezekiel 8:10 So I went in and saw; and behold every form of **creeping things**, and **abominable beasts**, and all the idols of the house of Israel, **portrayed upon the wall** round about.

Ezekiel 8:11 And there stood before them **seventy men** of the ancients of the house of Israel, and in the midst of them stood Jaazaniah the son of Shaphan, with every man his **censer in his hand**; and a thick cloud of incense went up.

Ezekiel 8:12 Then said he unto me, Son of man, hast thou seen what the **ancients** of the house of Israel do in the dark, every man in the **chambers of his imagery**? for they say, The LORD seeth us not; the LORD hath forsaken the earth.

Ezekiel 8:13 He said also unto me, turn thee yet again, [and] thou shalt see greater abominations that they do.

*Ezekiel 8:14 Then he brought me to the door of the gate of the LORD'S house which [was] toward the north; and, behold, there sat **women weeping for Tammuz.***

Ezekiel 8:15 Then said he unto me, Hast thou seen [this], O son of man? turn thee yet again, [and] thou shalt see greater abominations than these.

*Ezekiel 8:16 And he brought me into the inner court of the LORD'S house, and, behold, at the door of the temple of the LORD, between the porch and the altar, [were] about five and twenty men, with **their backs toward the temple of the LORD, and their faces toward the east; and they worshipped the sun toward the east.***

*Ezekiel 8:17 Then he said unto me, Hast thou seen [this], O son of man? Is it a light thing to the house of Judah that they commit the abominations which they commit here? for they have filled the land with violence, and have returned to provoke me to anger: and, lo, **they put the branch to their nose.***

*Ezekiel 8:18 Therefore will I also deal in fury: **mine eye shall not spare**, neither will I have pity: and though they cry in mine ears with a loud voice, [yet] will I not hear them.*

Isaiah 28:14 Wherefore hear the word of the LORD, ye scornful men, that rule this people which [is] in Jerusalem.

Isaiah 28:15 Because ye have said, we have made a covenant with death, and with hell are we at agreement; when the overflowing scourge shall pass through, it shall not come unto us: for we have made lies our refuge, and under falsehood have we hid ourselves:

*Isaiah 28:16 Therefore thus saith the Lord GOD, Behold, **I lay in Zion for a foundation a stone, a tried stone**, a precious corner [stone], a sure foundation: he that believeth shall not make haste.*

Isaiah 28:17 Judgment also will I lay to the line, and righteousness to the plummet: and the hail shall sweep away the refuge of lies, and the waters shall overflow the hiding place.

*Isaiah 28:18 And **your covenant with death shall be disannulled**, and your agreement with hell shall not stand; when the overflowing scourge shall pass through, then ye shall be trodden down by it.*

Isaiah 28:19 From the time that it goeth forth it shall take you: for morning by morning shall it pass over, by day and by night: and it shall be a vexation only [to] understand the report.

Isaiah 28:20 For the bed is shorter than that [a man] can stretch himself [on it]: and the covering narrower than that he can wrap himself [in it].

Galatians 5:19 Now the works of the flesh are manifest, which are [these]; Adultery, fornication, uncleanness, lasciviousness,

*Galatians 5:20 **Idolatry, witchcraft, hatred, variance, emulations, wrath, strife, seditions, heresies,***

Gradual road to cabalism

- From Christian belief
- To Interfaith
- To Humanism
- To New Age - To Cabalism and the Luciferic Illumination

Secular Humanism

J D Buck in Mystic Masonry states on page 216

“The only personal God Freemasonry accepts is humanity in toto... Humanity therefore is the only personal God that there is.

The United States Supreme Court ruled in 1961 in the case of *Tarasco v Watkins* that Secular Humanism is a religion.

The dangers of Freemasonry

*II Thessalonians 2:3 **Let no man deceive you by any means:** for [that day shall not come], except there come **a falling away first**, and that man of sin be revealed, the son of perdition;*

II Thessalonians 2:4 Who opposeth and exalteth himself above all that is called God, or that is worshipped; so that he as God sitteth in the temple of God, shewing himself that he is God.

II Thessalonians 2:5 Remember ye not, that, when I was yet with you, I told you these things?

II Thessalonians 2:6 And now ye know what withholdeth that he might be revealed in his time.

*II Thessalonians 2:7 For **the mystery of iniquity doth already work:** only he who now letteth [will let], until he be taken out of the way.*

II Thessalonians 2:8 And then shall that Wicked be revealed, whom the Lord shall consume with the spirit of his mouth, and shall destroy with the brightness of his coming:

II Thessalonians 2:9 [Even him], whose coming is after the working of Satan with all power and signs and lying wonders,

*II Thessalonians 2:10 And with all deceivableness of unrighteousness in them that perish; **because they received not the love of the truth, that they might be saved.***

*II Thessalonians 2:11 **And for this cause God shall send them strong delusion, that they should believe a lie:***

*II Thessalonians 2:12 **That they all might be damned who believed not the truth, but had pleasure in unrighteousness.***

*Hosea 4:6 My people are destroyed for **lack of knowledge**: because thou hast rejected knowledge, I will also reject thee, that thou **shalt be no priest to me**: seeing thou hast **forgotten the law of thy God**, I will also **forget thy children.***

*II Corinthians 6:14 Be ye not unequally yoked together with unbelievers: for what fellowship hath righteousness with unrighteousness? and **what communion hath light with darkness?***

*II Corinthians 6:15 And **what concord hath Christ with Belial?** or what part hath he that believeth with an infidel?*

II Corinthians 6:16 And what agreement hath the temple of God with idols? for ye are the temple of the living God; as God hath said, I will dwell in them, and walk in [them]; and I will be their God, and they shall be my people.

MASONIC ILLUMINATION - LUCIFERIAN

Dr. Robert Morey is the director of the Research and Education, a group dedicated to researching topics affecting Culture. He is a respected researcher of more than 20 years. In his book entitled "The Truth About Masons" from page 25(1993 edition) he states: -

"That there has been and are now Masonic authors who are 'Luciferian' cannot be denied. There are some New Age Masonic writers such as A.E. Waite, Hall, etc. who would have to be labeled as Luciferians."

From page 36

"Anyone who has ever read modern Masonic literature has run across dozens of passages where it is claimed that Pike is the spokesman for the craft."

What then does Albert Pike say: -

The candidate wishing to be initiated into masonry stands the lodge door, and is announced as 'a poor candidate in state of darkness'. From this 'darkness' the candidate

is to move into the light which will come from being shown secret mysteries of Freemasonry.

However, Albert Pike in 'Morals and Dogma' page 104-105 states: -

"Masonry like all the religions, Hermeticism and Alchemy, conceals its secrets from all except the Adepts and Sages, or the Elect, and uses false explanations and misinterpretations of its symbols to mislead those who deserve only to be misled; to conceal the truth which it calls light, from them, and to draw them away from it."

What is this light really?

According to Pike on page 321 of *Morals and Dogma*: -

"Lucifer the light bearer!...Lucifer, the Son of the Morning! Is it he who bears the light?... Doubt it not!"



MASONIC GOD - LUCIFER

The following is the infamous quote of Albert Pike. If you still believe the Taxil deception spread within freemasonry, then check out page 321, of the 1942 edition, of Albert Pike's *"Morals and Dogma"*.

"That which we must say to the crowd is -- We worship a God, but it is the God that one adores without superstition.

"To you, Sovereign Grand Inspectors General, we say this, that you may repeat it to the Brethren of the 32nd, 31st, and 30th degrees -- The Masonic Religion should be, by all of us initiates of the high degrees, maintained in the purity of the Luciferian Doctrine.

"If Lucifer were not God, would Adonay (The God of the Christians) whose deeds prove his cruelty, perfidy and hatred of man, barbarism and repulsion for science, would Adonay and his priests, calumniate him?"

"Yes, Lucifer is God, and unfortunately Adonay is also god. For the eternal law is that there is no light without shade, no beauty without ugliness, no white without black, for the absolute can only exist as two gods: darkness being necessary for light to serve as its foil as the pedestal is necessary to the statue, and the brake to the locomotive. "

"Thus, the doctrine of Satanism is a heresy; and the true and pure philosophical religion is the belief in Lucifer, the equal of Adonay; but Lucifer, God of Light and God of Good, is struggling for humanity against Adonay, the God of Darkness and Evil." ⁷

⁷ (Instructions to the 23 Supreme Councils of the World, Albert Pike, Grand Commander, Sovereign Pontiff of Universal Freemasonry, July 14, 1889. Recorded by A.C. De La Rive, La Femme et L'Enfant dans

In order to justify this severely flawed notion, Freemasons of 33rd degree quote from Revelations 22 verse 16: -

"I Jesus have sent my angel to testify unto you these things in the churches. I am the root and the offspring of David, and the bright and morning star."

then they quote from Isaiah 14 verse 12: -

"How art thou fallen from heaven, O Lucifer, son of the morning!"

The argument then is "See - same thing" in what must be the most quotation out of context in existence, for verse 13, the next verse states: -

"For thou hast said in thy heart, I will ascend into heaven, I will exalt my throne above the stars of God."

What does the Bible say about Lucifer

Isaiah 14:12 How art thou fallen from heaven, O Lucifer, son of the morning! [how] art thou cut down to the ground, which didst weaken the nations!

Isaiah 14:13 For thou hast said in thine heart, I will ascend into heaven, I will exalt my throne above the stars of God: I will sit also upon the mount of the congregation, in the sides of the north:

Isaiah 14:14 I will ascend above the heights of the clouds; I will be like the most High.

Isaiah 14:15 Yet thou shalt be brought down to hell, to the sides of the pit.

Isaiah 14:16 They that see thee shall narrowly look upon thee, [and] consider thee, [saying, is] this the man that made the earth to tremble, that did shake kingdoms;

Isaiah 14:17 [That] made the world as a wilderness, and destroyed the cities thereof; [that] opened not the house of his prisoners?

Isaiah 14:18 All the kings of the nations, [even] all of them, lie in glory, everyone in his own house.

Isaiah 14:19 But thou art cast out of thy grave like an abominable branch, [and as] the raiment of those that are slain, thrust through with a sword, that go down to the stones of the pit; as a carcass trodden under feet.

la Franc-Maçonnerie Universelle, page 588)) (Also See "Antichrist and a Cup of Tea," by Tim Cohen, page 235) (See Also "En Route to Global Occupation," by Gary Kah, pp 124-125 and pp 1133-116)

Isaiah 14:20 Thou shalt not be joined with them in burial, because thou hast destroyed thy land, [and] slain thy people: the seed of evildoers shall never be renowned.

I John 3:7 Little children, let no man deceive you: he that doeth righteousness is righteous, even as he is righteous.

I John 3:8 He that committeth sin is of the devil; for the devil sinneth from the beginning. For this purpose, **the Son of God was manifested, that he might destroy the works of the devil.**

II Corinthians 11:14 And no marvel; for **Satan himself is transformed into an angel of light.**

Acts 26:18 **To open their eyes, [and] to turn [them] from darkness to light, and [from] the power of Satan unto God, that they may receive forgiveness of sins, and inheritance among them which are sanctified by faith that is in me.**

Revelation 22:16 I Jesus have sent mine angel to testify unto you these things in the churches. I am the root and the offspring of David, [and] **the bright and morning star.**

THE WITCHCRAFT CONNECTION

William Schnoebelen an ex - 32nd degree Mason and ex- Wicca and occultist states the following on page 204 of book 'Masonry Beyond the Light': -

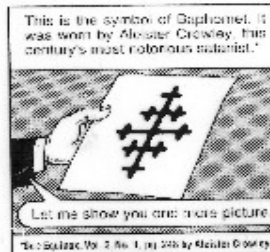

"There is something about the Lodge that has always attracted sorcerers. The list of occultists and witches in the last century who were freemasons read like a Who's Who of 20th century occultism:



- * Arthur Edward Waite - occult writer and Masonic historian
- * Dr. Wynn Westcott - member of the Societas Rosicruciana in Anglia and founding member of the occult Order of the Golden Dawn
- * Aleister Crowley - master satanist of this century and founder of the antichrist religion of Thelema.

- * Dr. Gerard Encausse'- (Papus) masterful author, teacher of the Tarot and leader of the occult Martinistes society
- * George Pickingill - the master warlock (male witch) of the 19th century England, leader of the "Pickingill Covens"
- * Annie Besant - leader of the occult Theosophical Society and Co-Masonic Hierarchy (Yes, there are female Masons!)
- * Alice Bailey - founder of the New Age organizations, Lucis (formerly Lucifer) Trust.
- * Bishop C. W. Leadbetter - Theosophist, mentor to the failed New Age "Christ", Krishnamurti, and prelate in the occult liberal Catholic Church.
- * Manly P Hall - Rosicrucian adept, author, founder of the Philosophical Research Society
- * Gerald B. Gardner - founder of the modern Wiccan (white Witchcraft) revival
- * Alex Sanders - self-styled, "King of the Witches" in London and one of the most influential leaders of Wicca after Gardner.

Would you really wish to belong to an organization that welcomed these powerful sorcerers into its midst with open arms?

In addition, there are the many minor occultists (as I was), who are in the lodge, drawn by its mysterious power.

There is real reason for this strong affinity between Masonry and witchcraft. It is because the Lodge is plugged into an international network of witchcraft,"

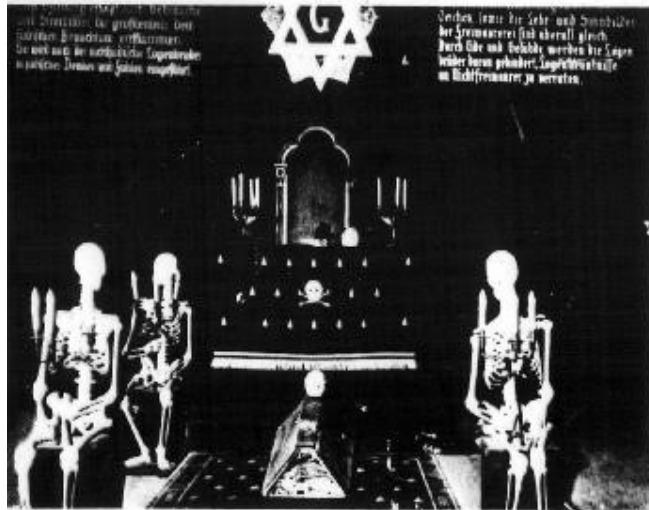

SIMILARITIES BETWEEN FREEMASONRY, THE OCCULT AND SATANISM

There are many similarities between Satanic witchcraft and Freemasonry: -

- Both are heavily laden with symbolry and ritual
- In both access to the organization is by recommendation only
- In both the initiate is blindfolded and led around with a rope (a cable tow) around his/her neck

- In both a sharp object is held against the initiates naked breast and he/she is made to swear that he will divulge none of the secrets of the order at pains of death
- In both death oaths are sworn
- In both the initiate is supposedly brought 'from darkness into light'
- In both the words 'so mote it be' feature prominently in the rituals.
- In both there is a search for the true name of God.
- In both Lucifer is proclaimed as the God of light and the true God
- In both the pentagram, the triangle in the circle, the trapezium and various other occultic symbols feature prominently in the symbolry
- Both contain rituals of burial and resurrection.
- Both have baptism ceremonies - in witchcraft a baptism in blood and in Masonry it is simply referred to as a baptism or 'lustration' rather, into wisdom
- Both use an altar as the central part of their meeting place
- Both have a ceremony Holy Communion type ritual - in Satanic ritual it involves the drinking of blood from a skull and in Masonry in the York rites Knights Templar (KT) degree, The candidate drinks an undisclosed (sealed) libation from a human skull
- The lodge layout and its symbolism simply ooze satanism as can be seen from the illustrations overleaf



William Schnoebelen an ex - 32nd degree Mason on page 66 of his 'Masonry Beyond the Light' describes the ritual in this as follows: -

"There is part of Freemasonry which requires a person to be a nominal Christian to join. This is the Commandery, the Knights Templar (KT). It is the pinnacle of the York Rite. It is the one degree where the prayers are offered in Jesus's name and the cross is part of the symbolism"

page 67

"The high point of the KT initiation is when the candidate is brought before a large, triangular table covered in black velvet illuminated by candles and

containing eleven silver goblets and a human skull enthroned on the bible (skulls figure prominently throughout the initiation)

(Snoebelen quotes here from the 'Illustrated Ritual of the Six of the Council and Commandery' by Charles Powner 1975 p)

"This is intended to be the Last supper. It seems but a grim mockery though. The visual effect is more satanic than Christian

"The candidate is told to partake of five libations... the fifth is the most sinister of all. The candidate is never told to whom this libation is drunk (it is sealed) and it is offered to him out of the human skull! he is told by the "Eminent Commander" to repeat a short oath which says in part:

"As the sins of the whole world were once visited upon the head of our Savior, so may all the sins of the person whose skull this once was, in addition to my own, be heaped upon my head, and may this libation appear in judgment against me, should I ever knowingly or willingly violate my most solemn vow of a Knight Templar, so help me God"

"To 'sell back" to Satan, under this solemn oath, sins that Jesus died for already, is an incredibly heinous slap in the face to the very Lord the templars profess to venerate!"

"Though most who take this oath do not understand what they have said, and think it is a light and frivolous thing to do, its spiritual consequences are devastating! Paul warns that:

Wherefore whosoever shall eat this bread and drink this cup of the Lord, unworthily, shall be guilty of the body and the blood of the lord (I Corinthians 11:27)

What the Bible says about this

Galatians 5:19 Now the works of the flesh are manifest, which are [these]; Adultery, fornication, uncleanness, lasciviousness,

*Galatians 5:20 **Idolatry, witchcraft, hatred, variance, emulations, wrath, strife, seditions, heresies,***

Acts 19:18 And many that believed came, and confessed, and shewed their deeds.

Acts 19:19 Many of them also which used curious arts brought their books together, and burned them before all [men]: and they counted the price of them, and found [it] fifty thousand [pieces] of silver.

Curses

Deuteronomy 27:26 Cursed [be] he that confirmeth not [all] the words of this law to do them. And all the people shall say, Amen.

Deuteronomy 28:16 Cursed [shalt] thou [be] in the city, and cursed [shalt] thou [be] in the field.

Deuteronomy 28:17 Cursed [shall be] thy basket and thy store.

Deuteronomy 28:18 Cursed [shall be] the fruit of thy body, and the fruit of thy land, the increase of thy kine, and the flocks of thy sheep.

Deuteronomy 28:19 Cursed [shalt] thou [be] when thou comest in, and cursed [shalt] thou [be] when thou goest out.

John 7:49 But this people who knoweth not the law are cursed.

Galatians 3:10 For as many as are of the works of the law are under the curse: for it is written, cursed [is] every one that continueth not in all things which are written in the book of the law to do them.

*Galatians 3:13 **Christ hath redeemed us from the curse of the law, being made a curse for us: for it is written, cursed [is] every one that hangeth on a tree:***

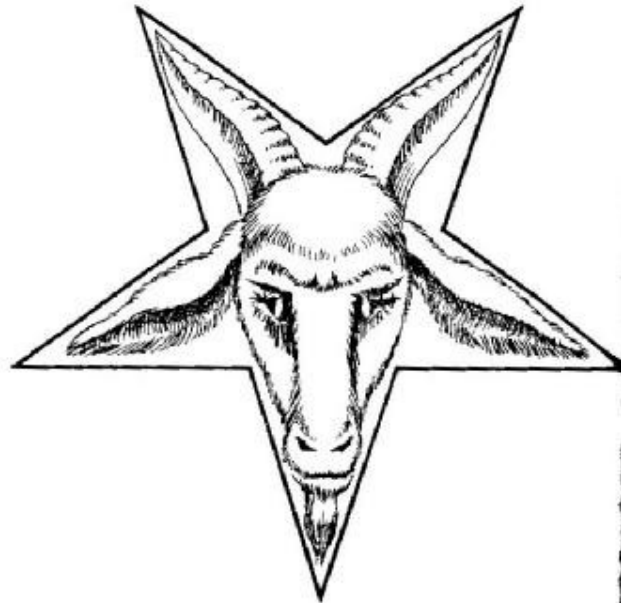

GOATS HEAD INSIDE SATANIC PENTAGRAM

CHAPTER THREE

Please note that from this chapter on the work is still in draft format and needs editing.

Where does Masonry come from?

- Ancient Mystery Religions
- Nimrod
- Egypt
- Assyria
- Babylon

MYSTERY BABYLON

In 1858 the Rev. Alexander Hislop quoting 275 authors wrote a book called 'The Two Babylon's' a book that has never been and is to this day still considered the definitive work on the subject, deals with the links between Catholicism and Babylon

In a summary of Hislop's analyses by Dr. D. Jeremiah in his 'The Turning Point' given on Short-wave radio over the Service, he traces the 'Mystery Babylon' mentioned in the of Revelations 17 in the Bible and the 'Abomination of' mentioned in the Book of Mathew 24 by Jesus Christ, quoting the prophet Daniel, indisputably to the Vatican. Here follows a summary of Hislop's studies: -

Mystery Babylon

Noah had a son called Cush who in turn had a daughter called Semiramis married her son Nimrod. they had a son Tammuz whom Semiramis claimed was miraculously conceived a ray of sunlight. At some point Tammuz was killed by a wild and after 40 days of weeping by Semiramis the boy was from the dead.

All over the world pagan religions surrounding this legend which involved the idol worship of Mother child.

In Assyria the mother was Ishtar and the son Tammuz

In Phoenicia the mother was Astarte and the son Baal In

Egypt the mother was Isis and the son Osiris

In Greece the mother was Aphrodite and the son Eros

In Rome the mother was Venus and the son Cupid

In India the mother was Isi and the son Iswara

In China the Holy Mother was Shing Moo and the child is unnamed

In Assyria the mother was worshiped by the offering of wafer toasts the 'Queen of Heaven' as was the case in Egypt.

In the book of Jeremiah 44 verse 15 in the bible we read about the burning of incense to the 'queen of heaven' and the pouring out of drink offerings to her.

Forty days of 'lent' memorializing the 40 days of weeping was a tradition in these times.

In the book of Ezekiel chapter 8, verse 13 - 14 we read about abominations committed by the Jews at the door of the gate of the temple toward North where there were women weeping for Tammuz.

At end of the feast of 'Ishtar' to celebrate the resurrection of Tammuz from the grave, part of this celebration involved the feast of 'Ishtar Eggs' symbolizing the new life and new form of Tammuz.

The tradition of Easter eggs comes directly from this feast.

King Nebuchadnezzar of Babylon adopted this religion and since Babylon has been synonymous with idol worship.

In Rome the feasts were celebrated by priests wearing vestments in a ceremony involving wafers shaped like the sun and drink .

The 'Mystery of Iniquity' mentioned in the book of II2 in the bible can be traced directly to the Babylon as a religion which grounded itself in Rome and other religions.

Greece
Rome

What does the Bible say about Mystery Babylon

Revelation 17:3 So he carried me away in the spirit into the wilderness: and I saw a woman sit upon a scarlet coloured beast, full of names of blasphemy, having seven heads and ten horns.

*Revelation 17:4 And the woman was arrayed **in purple and scarlet colour**, and **decked with gold and precious stones and pearls**, having a **golden cup** in her hand **full of abominations and filthiness of her fornication**:*

*Revelation 17:5 And upon her forehead [was] a name written, **MYSTERY, BABYLON THE GREAT, THE MOTHER OF HARLOTS AND ABOMINATIONS OF THE EARTH.***

*Revelation 17:6 And I saw the woman **drunken with the blood of the saints**, and with the blood of the martyrs of Jesus: and when I saw her, I wondered with great admiration.*

Revelation 17:7 And the angel said unto me, Wherefore didst thou marvel? I will tell thee the mystery of the woman, and of the beast that carrieth her, which hath the seven heads and ten horns.

Revelation 17:8 The beast that thou sawest was, and is not; and shall ascend out of the bottomless pit, and go into perdition: and they that dwell on the earth shall wonder, whose names were not written in the book of life from the foundation of the world, when they behold the beast that was, and is not, and yet is.

*Revelation 17:9 And here [is] the mind which hath wisdom. The **seven heads are seven mountains, on which the woman sitteth.***

*Matthew 24:24 For there shall arise false Christs, and false prophets, and **shall shew great signs and wonders; insomuch that, if [it were] possible, they shall deceive the very elect.***

The Knights Templar

From 'An Encyclopedia of Religion' by Vergilius Ferm page 420 we under 'Knights Templar': -

"The name of this congregation was derived from the fact that their first house was a part of Baldwin's palace lying next to the former mosque of al- Akra, the so-called 'Temple of Solomon' they were subject only to their own Grand Master and the Pope... The power of the Templars grew swiftly, not so much because of their large land holdings as because they became notable international bankers, and their temple in Paris became the center of the world's money market The role of international financiers fell quite naturally to them since the Templars' strongholds were scattered throughout both the East and the West, and made exchange with the East possible.... Upon the suppression of the order most of the templars entered the ranks of their former rivals 'The Hospitallers'

Jerusalem

From John J. Robinson's book 'The Lost Secrets of Freemasonry -in Blood' which deals at length with the Knights Templar is considered the most modern and authoritative work on the, he writes about the 'Temple Mount' in Jerusalem where the original temple stood and where the 'Dome of the Rock' Islamic now stands, he makes the point that Islam, the Vatican, Christians and the Freemasons all want access to this area. we read on page 343: -

"This is the place where, more than anywhere else, the central religious attitude of Freemasonry could be applied with most beneficial effect to the rest of

the world, where men who avow their beliefs in a supreme being could meet in brotherhood and bear full respect for the other man's mode of worship."

From John J. Robinson's book 'The Lost Secrets of Freemasonry - in Blood' he states further: -

"The Catholic church has suggested that Jerusalem become an international city, a concept that may have merit but does not solve the problem.

It is interesting to note the article on the following page the sale of Jerusalem by Peres.

Hospitallers

Jesuits Ignatius De Loyola

Evidence in David Yallop's book entitled 'In God's Name' links with Vatican and the Vatican Bank with the P2 Lodge in Italy. Mr. Yallop frequently shows a list of 100 names of people in the Vatican that contains details of membership in Masonic lodges. Included in the list is the of the current Pope.

Ignatius De Loyola

Dr. Alberto Riviera draws attention to a well-known fact on page, of the volume entitled 'The Godfathers' namely that Ignatius Loyola founded the Jesuit Order, on page 24 that Loyola was a master of occultic skills, on page 27 volume 12 entitled 'Alberto' of his books on the Vatican that senior members of the are members of the Freemasons, on page 32 of Volume 14. Pope Pius XII was a Mason, on page 30 (copy attached) where the masons fit into the order of things, -under the Jesuits.

The Jesuit concocted "Learned Elders in control of Freemasonry"

The Jesuits concocted a document entitled the Protocols of the Learned Elders of Zion for no other reason than to ferment a war and one that would rid them of the rising tide of Orthodox Jews to boot.

From "World Conquest through World Government" by Victor E. Marsden⁸, which was put out by Britons Publishing Company in 1969 which contains "The Protocols of the Learned Elders of Zion we read: -

In protocol no 4 paragraph two, page 30 we read:

"Gentile masonry blindly serves as a screen for us and our objects"

Protocol 11 page 50:

".. secret Masonry which is not known to, and whose aims are not even so much as suspected by, these goy cattle attracted by us into the 'show' army of Masonic lodges in order to throw dust in the eyes of their fellows"

Protocol 15 page 60

⁸ Subsequently accredited as authentic on Appeal in the High Court of Switzerland

"We shall create and multiply free masonic lodges in all the countries of the world, absorb into them all who may become or who are prominent in public activity, for in these lodges we shall find our principal intelligence office and means of influence. All these lodges we shall bring under one central administration, known to us alone and to all others absolutely unknown, which will be composed of our learned elders."

page 61

"The class of people who most willingly enter secret societies are those who live by their wits, careerists, and in general, people, mostly light minded, with whom we shall have no difficulty in dealing and in using to wind up the mechanism of the machine devised by us.... It is natural that we and no other should lead masonic activities."

"The goyim enter the lodges out of curiosity or in the hope of getting a nibble from the public pie, and some of them in order to obtain a hearing before the public for their impracticable and groundless fantasies: they thirst for applause, of which we are remarkably generous. And the reason why we give them this success is to make use of the high conceit of themselves to which it gives birth"

Page 61

"We execute masons in such wise that none save the brotherhood can ever have a suspicion of it, not even the victims themselves of our death sentence, they all die when required as if from a normal illness knowing this, even the brotherhood in its turn dare not protest. By such methods we have plucked out of the midst of masonry the very root of protest against our disposition."

Jesuit Oath

CEREMONY OF INTRODUCTION AND EXTREME OATH OF THE JESUITS

(Given to a Jesuit of minor rank when he is to be elevated to a position of command)

The following extract is taken from the book entitled "The Engineer Corpse of Hell" by Edwin A Sherman page 118 as quoted by Dr. Rivera, in his book entitled "Double Cross" (one of several volumes on the subject) put out by Chick Publications P O Box 662 Chino California. 91708-0662 USA. Dr. Alberto Rivera Romero is an ex-Jesuit Priest and Bishop in the Old Roman Catholic Institution, and was also the director of the Parish School in San Lorenzo, Spain, ID registration no 107048 1967 under the rule of dictator Franco. Since 1978 he has been involved in full time historical and biblical research relating to the Roman Catholic Institution. His contact address given in 1981 is: - Dr. Riviera, A.I.C. Box 31340, Los Angeles, California 90032 USA

"My son heretofore you have been taught to act the dissembler among the Roman Catholics to be a Roman Catholic, and to be a spy even among your own brethren; to believe no man, to trust no man, among the reformers to be a reformer, among the Huguenots to be a Huguenots; among the Calvinists to be a Calvinist; among the Protestants generally to be a Protestant; and obtaining their confidence, to seek even to preach from their pulpits, and to denounce with all the vehemence in your nature our Holy religion and the Pope and even to descend so low as to become a Jew

amongst the Jews. That you might be enabled to gather together all information for the benefit of your order as a faithful soldier of the Pope.

You have been taught to insidiously plant the seeds of jealousy and hatred between the states that were at peace and incite them to deeds of blood, involving them in war with each other and to create revolutions and civil wars in communities, provinces and countries that were independent and prosperous, cultivating the arts and the sciences and enjoying the blessings of peace. To take sides with the combatants and to act secretly in concert with your brother Jesuit who might be engaged on the other side, but openly opposed to that with which you might be connected; only that the church might be the gainer in the end in the conditions fixed in the treaties for peace ..and that the end justifies the means.

You have been taught your duty as a spy to gather all statistics, facts and information in your power from every source: to ingratiate yourself into the confidence of the family circle of protestants and heretics of every class and character as well as that of the merchant, the banker, the lawyer, among the schools and universities in Parliaments and legislatures, and in the Judiciaries and Conceals of the State and to 'be all things to all men' for the Pope's sake, whose servants we are unto death.

You have received all your instructions heretofore as a Novice, a Neophyte, and have served as a coadjutor, confessor and priest, but you have not yet been vested with all that is necessary to command in the army of Loyola in the service of the of the Pope.

You must serve the proper time as the instrument and executioner as directed by your superiors; for none can command here who has not consecrated his labours with the blood of the heretic; for 'without the shedding of blood no man can be saved'. Therefore, to fit yourself for your work and make your own salvation sure, you will, in addition to your former oath of obedience to your order and allegiance to the Pope, repeat after me: -

'I, A B, now in the presence of almighty God, the blessed Virgin Mary, the blessed Michael, the Arch Angel, the blessed St. John the Baptist, the Holy Apostles, St. Peter and St. Paul and all the Saints and sacred hosts of heaven etc. at length.... promise and declare that I will, when opportunity presents, make and wage relentless war, secretly or openly, against all heretics, Protestants and liberals, as I am directed to do. To extirpate and exterminate them from the face

of the whole earth and that I will spare neither age. sex or condition and that I will hang, burn, waste, boil, flay, strangle and bury alive these infamous heretics, rip up the stomachs and wombs of their women and crush their infants heads against the walls, in order to annihilate forever their execrable race. That when the same cannot be done openly I will secretly use the poisoned cup, the strangulating cord, the steel of the poniard, or the leaden bullet, regardless of the honour, rank. dignity, or authority of the person or persons, whatever may be their condition in life, either public or private, as I at any time may be directed to do b y any agent of the Pope or superior of the brotherhood of the Holy Faith, the society of Jesus."

Dr. Rivera maintains in this book, which was published in 1981 that there are some 102,000 Jesuits under this oath in operation at any given time. This number includes those outside the priesthood. These Jesuits are controlled by a Jesuit General known as 'The Black Pope'.

Dr. Rivera describes several Bible seminaries that were infiltrated and financially destroyed under his command. He describes in detail the infiltration techniques used. The techniques, once known, are sometimes easily identified when they are put into operation.

METHOD OF INFITRATION

According to Ex Jesuit Priest and Bishop in the Old Roman Catholic Institution, Alberto Riviera Who was director of the parish School in San Lorenzo, Spain. Since before 1979 he was involved in full time historical and biblical research relating to the Roman Catholic Institution.

Contact Address:

Dr. Riviera
A.I.C. Box 31340
Los Angeles
California 90032 USA

There are approximately 102,000 Jesuits this number includes those outside the priesthood.

The Jesuits are controlled by the **Black Pope** (The Jesuit General)

The media is controlled in The USA by Jews

- and around the world by the New World Order
- Are supported by a system of *crepitation* and *discreditation* DETERMINED BY JESUITS e.g.

RSA - Tony O Reilly head of the Argus group and self-confessed Jesuit

Infiltration Campaign

Began around 1550

Today takes the shape of the Ecumenical / Charismatic Movement and some Fundamentalist "Churches"

Young boys - trained Jesuits used to gather information infiltrate schools and influence teachers etc. taught how to play on sentiments and use emotional blackmail and directive syllogistic argument. Later they infiltrate seminaries and bible schools.

The Holy Office still exists and there in is a record of every protestant pastor and his members. For the purposes of the new inquisition.

Presentation to students:

"I have Many relatives in the Catholic Church who love the Lord and are saved Christian Believers. It is a Christian Church "

"Those who don't believe this are CAUSING TREMENDOUS DIVISION in their own Christian faith"

"It causes all kinds of CONFUSION, DISTORTION and DISSENSION. It must stop. We must PREACH LOVE."

Presentation to Pastor

"I have suffered at the hands of the catholic Church etc..."

Pastors are planted with prostitutes etc.

Jesuits Set plan for destroying a man of God WHO WILL NOT COMPROMISE.

1 Discredit Him

a) Destroy his reputation by lying about him, twisting something he said, making him look like an enemy of the country, get him into trouble with the officials, frame him with a woman (Once a pastor was called to a home late at night, on the way was a woman in distress, when he stopped to help she screamed rape, tore her dress and her partner photographed them).

B) production of double Destruction of credit and business etc.

2 Isolate Him

b) A letter writing and whispering campaign stating that he is too 'CONTROVERSIAL' a TROUBLE MAKER, that he is AGAINST UNITY, he is NOT SHOWING GODS LOVE, he has his OWN STRANGE DOCTRINES or BELIEFS,

c) He is Isolated from Pastor or Friends

d) He has had a NERVOUS BREAKDOWN so everything he says is unreliable

3 Death by various means

a) car accident - Hospital - wrong medication accidents of nurses - He gets COMPLICATIONS and dies

b) Food poisoning

c) fed mind changing drugs - mental institution

d) mysterious fight with stranger - rigged - knifed

e) Killed in unrest etc.

b) brain tumor etc. see Protocols

"Ecumenical Forces under Pope John XXIII the protestants were to be called ' Separated Brethren' instead of 'Heretics'" (The Vatican Moscow Washington Alliance by Avro Manhattan 1982)

The first protestant groups were infiltrated - the Seventh Day Adventists first, then Full Gospel Businessman, then into Baptist, Methodists, Presbyterians, Lutherans until eventually the Mormons and Jehovah's Witnesses.

In most Seminaries, Universities, Colleges: -

A detailed system of "**Liberal Theology**" and "**Higher Criticism**" is taught which seeks only to discredit the Bible. The **Dead Sea Scrolls are controlled by the Rockefeller Museum and the chief researcher has for years been a Jesuit.**

Dispensational charts by Darby Schoenfeld and Kelly are used

CFR members do the infiltration into universities

The networking includes

**The Catholic Youth Action,
Legion of Mary and
Knights of Columbus
(Catholic Masonic Order)
Knights of Da
Gama in RSA**

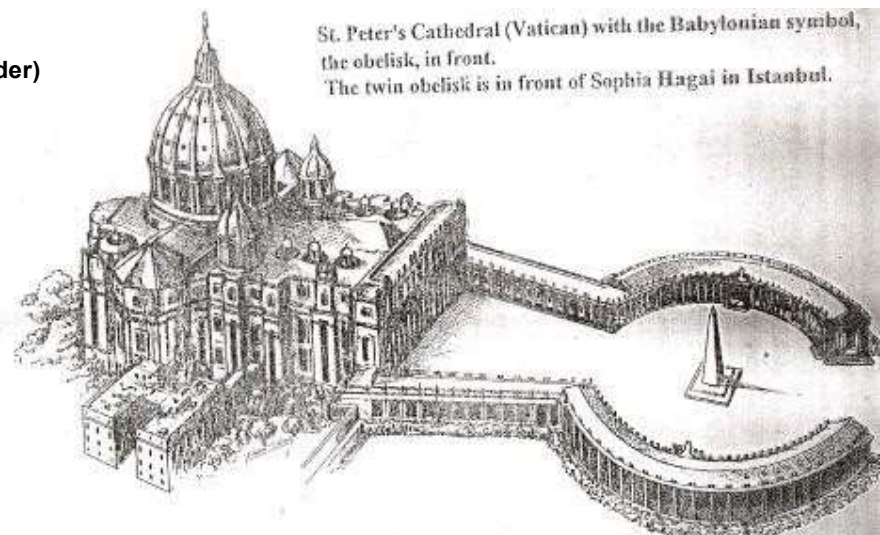

St. Peter's Cathedral (Vatican) with the Babylonian symbol, the obelisk, in front.
The twin obelisk is in front of Sophia Hagai in Istanbul.

CHAPTER FOUR

The Political interconnections

The Palladium

Albert Pike wrote to Giuseppe Mazzini in a letter dated 22/1870, which letter was published in a book called 'Occult Theocracy' by Lady Queensborough on pages 208 - 209: -

"We must create a super rite, which will remain unknown, to which we will call those masons of high degree whom we shall select. With regard to our brothers in masonry these men must be pledged to the strictest secrecy. Through this supreme rite we will govern all freemasonry which will become the one international centre, the most powerful because its direction will be unknown."

From Occult Theocracy above page 216: -

"In any country, in any rite the existence of which is acknowledged. Thus, it was particularly the initiates of the thirty-third degree Scottish Rites, who, owing to their extensive international ramifications, were privileged to recruit adepts for Palladism. That is why the Supreme Rite created its Triangles (the name given to Palladium Lodges)by degrees, but these were established on a firm base, the lowliest of its initiates being brothers long tested in ordinary masonry"

Politicians such as George Bush George Washington Pike Both a list of the British royalty and countless others are also

Historian Edith Starr Miller quoted in Occult Theocracy pg. 216 217 states: -

"The Holy See of the Dogma for the whole Masonic world was set up at Charlestown, the sacred city of the Palladium. Pike the Sovereign Pontiff of Lucifer, was the president of the Supreme Dogmatic directory, composed of the ten brothers of the highest grades who formed the Supreme College of Emeritus Masons. The Sovereign Executive directory of High Masonry was established at Rome under Mazzini himself"

Illuminati

The palladium is followed by the Illuminati.

From 'Satan's Angels Exposed' by Salem Kirban in conjunction with Gary G. Cohen pg. 147-150 we read: -

"The order of the Illuminati was founded on 1 May 1776 by Dr. Adam Weishaupt. Dr. Weishaupt was professor of Canon Law at the University of Ingolstadt in Bavaria. Weishaupt, although born a Jew, was a convert to Roman Catholicism. He became a Jesuit priest only to break with that order to form his own organization... In 1779 he divided his secret organization into three classes: Novice, Minerval and Illuminated Minerval...."

by the time a member had reached the grade of Illuminated Minerval he learned the ultimate aims of the order."

- 1 Abolition of ordered government
- 2 Abolition of private property
- 3 Abolition of inheritance
- 4 Abolition of patriotism
- 5 Abolition of religion
- 6 Abolition of the family (via abolition of marriage)
- 7 Creation of a world government

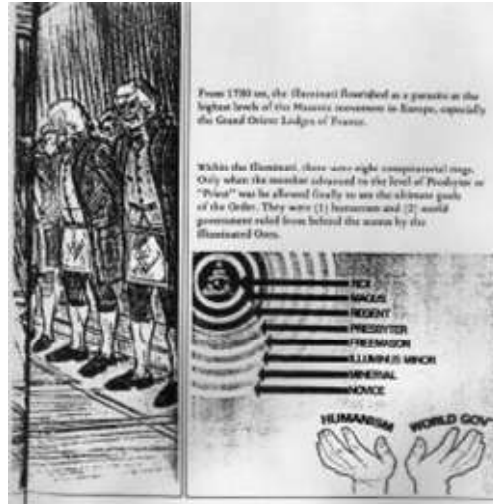

Weishaupt wrote to his chief assistant, Cato:

'The most admirable thing of it all is that great protestant and reformed theologians (Lutherans and Calvinists) who belong to our order really believe they see in it the true and genuine mind of Christian religion. Oh man, what cannot you be brought to believe?' These people swell our numbers and fill our treasury; get busy and make these people nibble at our bait.... but do not tell them our secrets. they must be made to believe that the low degree that they have reached is the highest

"Weishaupt gradually infiltrated the Freemasons. On July 161782 at the congress of Wilhelmsbad, an alliance between illuminism and Freemasonry was finally sealed. On that day the leading secret societies were infiltrated, and to some degree united... more than 3 million members! "

on page 153 of Mr. Kirban's book we read: -

"Dr. Adam Weishaupt, founder of the order of the Illuminati adopted the All-Seeing Eye symbol at the time he founded his Order on May 1 1776. The symbol is a pyramid with its top triangular stone being an eye. This symbol is found on the back of the United States \$1 bill. At the base of the pyramid is the date 1776. Many in error, believe this refers to the date of the signing of the Declaration of Independence. This is not solely true. It refers also, according to many, to the date Weishaupt founded the order of the Illuminati.

One Dollar Bill

On July 4, 1776 Thomas Jefferson and John Adams (both Masons) and Benjamin Franklin (a Rosicrucian) were asked to design a seal for the American One dollar Bill. The federal reserve system. Today that bill carries all the symbols of the illuminati and the Masons as illustrated: -



It has the face of Washington

It has the "G" of masonry to the left of the face. The G stands for the Great Architect of the Universe (GAOTU) or the Great Geometrician



to the right of the face is a seal containing a square with 13 stars in it a scale and a key denoting the scales of justice and the Key to Illumination or of the Pope, the choice is yours.

On the reverse is the all-seeing eye of Horus (or Osiris, the son of the Egyptian Goddess of the resurrection Isis who was worshipped through a ceremony involving a wafer) over a trapezium containing 13 levels and with the date of the formation of the Illuminati at its base and not the date of American independence as is commonly believed. The wording around it means 'Annuet Coeptus' - Announcing the birth of - 'Novus Ordo Seclorum' - a New Order which is Secular.

The eagle (which started off as a phoenix) holds 13 arrows, a sprig with 13 leaves and 13 olives, has 13 stars in the shape of the templars cross over its head, has 33 wing feathers. There are 33 wing feathers (33 degrees in Masonry) and nine tail feathers (The 9 unknown men). Note also that 13 is a prominent Kabbalistic and Satanic number.

Washington DC

George Washington wore his Masonic regalia when he laid the foundations for Washington city. The original plans for the city were such that the symbols of Masonry were clearly from their layout. To this day the square and, the Templars star and the pentagram can be seen in the streets from satellite photographs of the city. Canberra, the of Australia is the same as it was designed by Sir Griffin a famous masonic city planner.

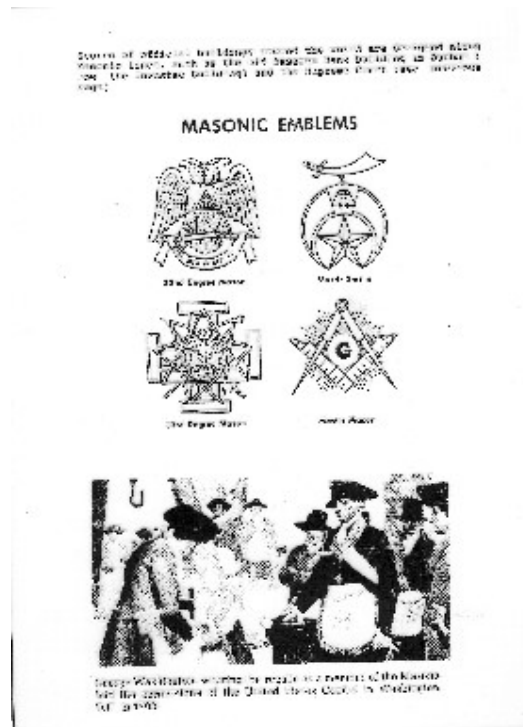

Scores of official buildings around the world are designed along lines, such as the old Reserve Bank building in Durban (the Investec building) and the Supreme Court (see previous)

Other Members of the illuminati include Karl Marx, Giuseppe and Albert Pike (Sovereign Grand Inspector general of and Brigadier General of the Confederate army) an and admiral of the Jewish Kabbalah (ibid 157-159)

Today's network

The Lucis (Lucifer) Trust

From 'Global Tyranny Step by Step the United Nations and the New World Order '
page 4: -

"The high priestess of theosophy cursed the God of the Bible as 'capricious and unjust'. He was merely 'a tribal God and no more', she maintained. In Madame Blavatsky's twisted mind, the Bible had it all backwards; it was really Satan who was the victim of Jehovah.

According to Blavatsky's biblical hermeneutics:

Once the key to Genesis is in our hands, the scientific and symbolical Kabbalah unveils the secret. The Great Serpent of the Garden of Eden and the "Lord God" are identical.

After she passed away in 1891, the mantle of leadership for the worldwide theosophical movement fell to Annie Besant, a militant feminist and a member of the Fabian Socialist Society of England. A close friend of George Bernard Shaw, H G Wells, and other leading Fabians.

Besant was followed by Alice Bailey, who together with her husband, Foster, constructed much of the foundation of what is now known as New Age religion. Unabashedly acknowledging their demonic sympathies, they launched 'Lucifer' Publishing Company, which published the theosophical periodical Lucifer. Realizing later that perhaps the Christian world was not yet ready for their open preference for Satanic religion, they changed the name to 'Lucis Publishing Company'. The Lucis Trust, established by the Baileys in 1922, continues to serve as the umbrella organization and programs that are key catalysts of the emerging new world religion. These include the Arcane School, World Goodwill, Triangles, Lucis Publishing, Lucis Productions, Lucis Trust Libraries, and the New Group of World Servers.

A New Age Network.

According to Lucis Trust, 'World Goodwill is recognized at the United Nation' and is 'represented at regular briefing sessions at the United Nations in New York and Geneva'. The 'regular weekly broadcasts of talks given at World Goodwill Forum meetings and programs produced by Lucis Productions' in London and New York are beamed by Radio for Peace International in English, Spanish, German, and French, on short-wave, to a 'worldwide audience' from the UN University for Peace in Costa Rica. According to spokesmen at the Lucis Trust, all people of good will, whether they realize it or not, belong to the New Group of World Servers (NGWS) who will bring about 'spiritual unfoldment' and 'lead humanity into a new age of peace and plenty'.

'Humanity is not following a haphazard or uncharted course- there is a Plan,' say the Lucis theosophists. And, 'Men of goodwill who cooperate form part of the new group to implement the Plan.' The 'Plan' involves a 'spiritual Hierarchy of the planet' and the building of a synthetic unity' that will be manifested in an 'inner center or subjective world government, whose members are responsible for the spread of those ideals and ideas which have led humanity onwards from age to age'. The leaders of the New Group of World Servers provide the vision and mold public opinion.' But there is yet a higher class of adepts. 'Behind these leaders and the co- operating men of goodwill', we learn, 'are the Custodians of the Plan', the 'inner spiritual Government of the Planet.'

According to these possessors of esoteric wisdom, 'People in the world at this time can be divided into four groups':

First the uninformed masses They are, however, enough developed to respond to the mental suggestion and control of more advanced people.

Second, the middle classes - both higher and lower Because they can read and discuss and are beginning to think, they form the most powerful element in any nation.

Third, the thinkers are everywhere They are steadily influencing world affairs - sometimes for good and sometimes for selfish ends.

Fourth, the New Group of World Servers. These are the people who are building the new world order ... They own to no creed, save the creed of Brotherhood, based on the One Life. They recognize no authority save that of their own souls."

The Vatican

In Revelation 17 the 'Whore of Babylon' (denoting spiritual) is described as sitting on seven hills, being drunk with the blood of the martyrs of Christ, surrounded by a sea of blood and riding on the beast which is described as a government with ten heads (sections), and controlling the nations.

Well Rome sits on seven hills.

The Vatican is the primary financier of the world's major lending institutions and therefore dictates its terms to the nations. It sits firmly on the beast (the European Community and its Provisional World Government, to which all our leaders refer to as the coming New World Order). it is interesting to note that the European headquarters in Brussels is built like an upside-down cross with the arms broken (exactly like the ceremony of satanic ritual requires) and that its main frame computer which controls all trade under the Maastricht treaty is called 'The Beast'.

Note the official advertisement of the European Community overleaf. Note the picture of the original painting of the tower of Babel on the previous page.

Also note the unmistakable similarity between the two pictures. Note also that the stars are upside down pentagrams, exactly like the rendition of the Masonic and templar God Baphomet, Satan himself. There are 10 stars, five on each side, one for each member nation state and for each region that the world is divided into under the provisional World Government. (see illustration of that on the following pages)

During the Inquisition it made itself guilty of the blood of the martyrs of Christ.

It is now planning on setting up on the Temple Mount with 'The Beast', aided by its lackeys, the Masons, the Illuminati, the Learned Elders - all offshoots of the original occultic mysticism that Ignatius de Loyola the founder of the Jesuits and father of Masonic doctrine put together and gave vent to organizations of secrecy and infiltration illustrated overleaf, - all for the attainment of one single goal:- the eradication and suppression of the belief in God through Secular Humanism and the replacing thereof with the belief and worship of Lucifer!

In 1500 there was corruption in the churches; - 'Plato's' was the popular solution; - 'If wise men, well paid in charge, then there will be no corruption'; they wanted humanist thinkers in power but first, they had to destroy world order and do it secretly. Ruskin (father of the Society), Marx, Pike Weishaupt etc. all shared the philosophy of Plato, who's ideal society included the following: -

- 1 The elimination of marriage and the family
- 2 All men would belong to all woman
- 3 Children resulting from these promiscuous unions would be taken over by the government, as soon as they were weaned. They would be raised anonymously by the state
- 4 Woman would be equal with men
- 5 Woman would be expected to fight wars with men and perform labour like men
- 6 Selective breeding of men and woman will take place under government control
- 7 Children considered inferior or crippled in this breeding process would be destroyed

Bizarre as that may seem, Luciferian dogma and world domination that secretly drives those that today control the world. The fulfillment of prophecy is inescapable - men have been greatly deceived and given over to great delusion as it is stated in the, in II Thessalonians chapter 2 verse 7: -

For the Mystery of Iniquity doth already work: only he who now letteth will let until he be taken out of the way. (8) and then shall that wicked be revealed, whom the Lord shall consume with the spirit of His mouth and the brightness of His coming: (9) Even Him who's coming is after the working of Satan with all power and signs and lying wonders, (10) and with the deceivableness of unrighteousness in them that perish; because they received not the truth that they may be saved. (11) And for this cause God shall send them strong delusion that they should believe a lie; (12) That all might be damned who believed not the truth, but had pleasure in unrighteousness."

The Club of Rome

The Provisional World Government

For a clear link between Freemasonry, the Illuminati and other international organisations one could hardly refer to a better book than '*En Route to Global Occupation*' by Gary Kah, a high-ranking USA Government liaison, winner of myriads of scholastic awards and listed as one of the Who's Who of Emerging Leaders in America.

The essence of the book is that there is in existence "**A New World Order**" in such an advanced stage of planning, precisely accurate in relation to *the Protocols of Zion* and the aims of the Illuminati, being fostered by their foot soldiers, the Masons.

Our leaders all speak freely of "the New World Order" and it is even subtly referred to in the preamble of our interim Constitution which states that there is "*a need for a new order*". President George Bush gave it clearest vent on January 29 1991 when he gave his state of the union address in which he said: -

*We are Americans: part of something larger than ourselves. What is at stake is more than one small country; it is a big idea: a **New World Order**, where diverse nations are drawn together in common cause to achieve the universal aspirations of mankind. The world can therefore seize this opportunity to fulfill the long-held promise of a **New World Order**... yes, the United States bears a major share of the leadership in this effort"*

Minister Pik Botha in debate with Thabo Mbeki on the TV program Agenda, just before the elections, repeatedly told Mr. Mbeki that "*the **New World Order** will not allow that*" President Mandela's address to the **Joint Houses of Congress** in the USA after his two weeks visit with David Rockefeller was described as "*the best description of the new World Order we have listened to yet*". When Mandela returned to the RSA, he openly gave his support to the New World Order.

No wonder because in 1989 **The Provisional World Government** was formed subsequent to about two decades of activity by the **World Constitution and Parliament Association** of which **Chief Minister Mangasuthu Buthelezi, Bishop Tutu, Dennis Brutus, and various other dignitaries including Chief Justices, Presidents, Kings, Dictators of every country in the world** are all *honorary founding sponsors*. They adopted the **Club of Rome's** map dividing the world into 10 regions of which the **South African Development Community (SADC)** is region 4, all in deadly accuracy of the prophecies of Daniel in the Old Testament and those of John's in the Book of **Revelations** in the New Testament of the Bible. Indeed, numerous similar documents set out how the New World Order is to be ushered in, via the establishment of **a one**

world religion⁹. In 1996 the Constitutional Court upheld a ruling that the Bible has nothing to do with a church's laws.¹⁰ In March 1996 **the injectable smart card (ICBM 666)** controlled by a computer called "**The Beast**" was tested on 80 women in the First National Bank in South Africa. "Oh man how easily thou art led astray!"

The Tavistock Institute – Workshop

The Council on Foreign Relations

The Royal Institute of International Affairs

The Bilderbergers

The Tri Lateral Commission

The Mafia Yakuza and Triads

Multinationals

Ronald Nash in his book "Liberation Theology" says: -

"It is not the market but governments that create monopolies by granting organizations the exclusive privilege of doing business or by establishing de facto monopolies through regulatory agencies whose purpose is the encouragement of competition but whose end result is the restriction of competition."

Some more headings to follow: -

The Committee of 300

The UN

Conditionality Treaties

The Rio Summit

The Iron Mountain Report

⁹ The UN has endorsed the highly anti-Christian Interfaith Constitution of the **World Council on Religion and Peace** and said that nation states that do not do so can expect little help from the international lending institutions as they would not have been party to fostering a climate for world peace and harmony.

¹⁰ Case No Ct 42/96

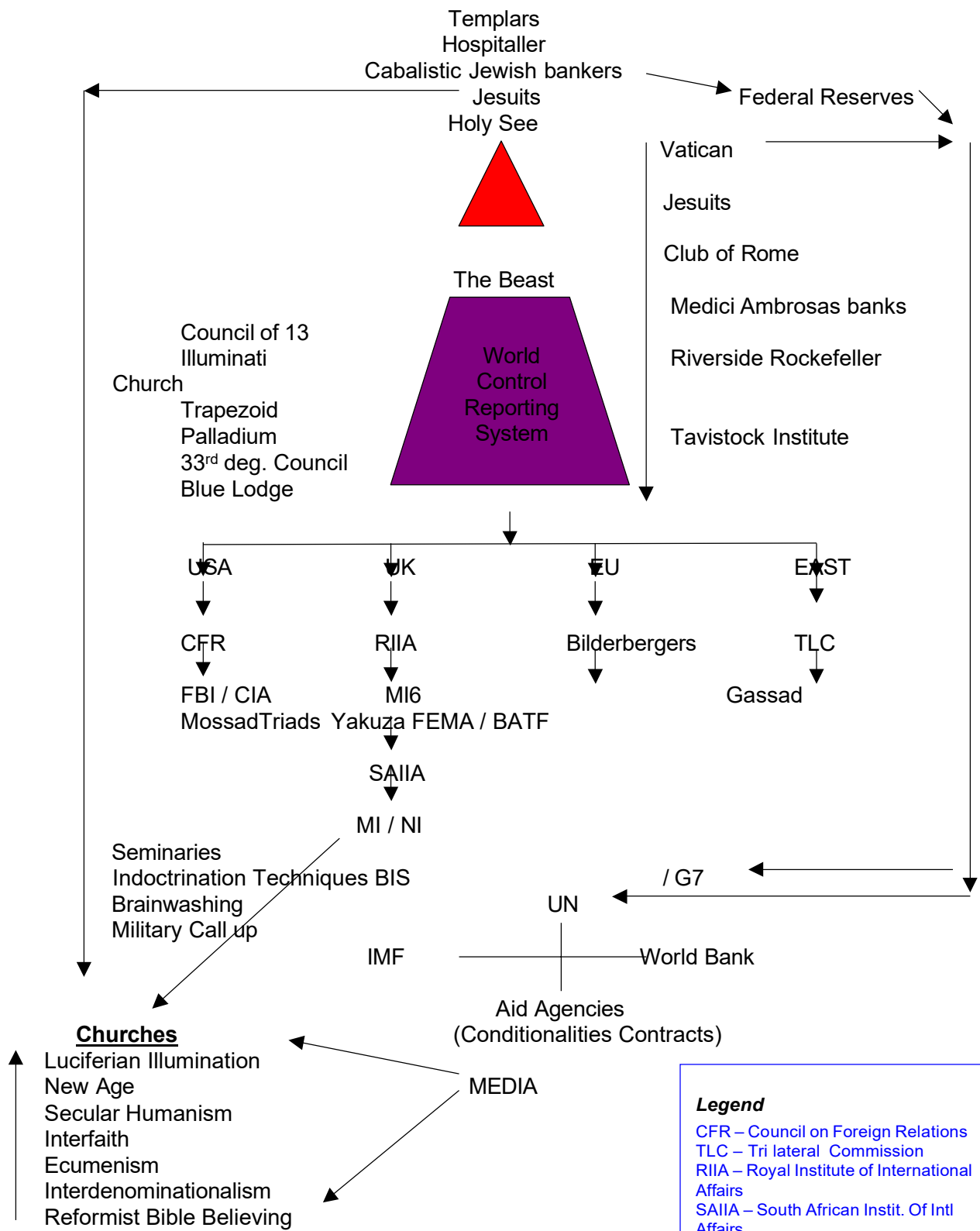

Related organizations to Freemasonry

Scottish, Irish, English, Oriental, African, Dutch, French, esoteric and European constitutions of Freemasonry

Ancient Arabic Nobles of the Mystic Shrine - Islamic Masons – Petro Dollar Sheiks

Order of David - Jewish Masons – Cabalistic Jews Mainly

Knights of Da Gama – Catholic Masons in USA Knights of Columbus

The Order of the Eastern Star – Female Freemasons, also known as the Co-Frees

Order of De Molay – for you Masonic Boys

Job's daughters / Daughters of the Nile, - for young Masonic Girls

GROTTE MOVPER – Germanic Masonry

Ordo Templi Orientis – Eastern Esoteric Masonry

The Palladium – Also known as

Triangle lodges for aspiring politicians

The Trapezoid – for experienced

politicians and statesmen

The 33rd degree council – as above

The Jesuits – founders of Freemasonry under Ignatius De Loyola.

The Round Table / Rhodes club – same routes as above

The Hermetic Order of the Golden dawn

Gnomes of Zurich

The Theosophical Society

The Merovingians

The Bilderbergers

The Illuminati

The Priure de Sion - / current version of the discredited Learned Elders of Zion

The Knights Templar

The Hospitallers

Cabbalistic organisations

The order of Memphis and Misraim – intimately connected to Freemasonry

LAWCAP

Tiil Society

Vril Society

The Satanic Church - Anton La Vey

The Club of Rome

The Tavistock Institute

COSMOS

These are some of the main ones – the myriad of New Age organisations supportive of the Freemasons are too many to mention.

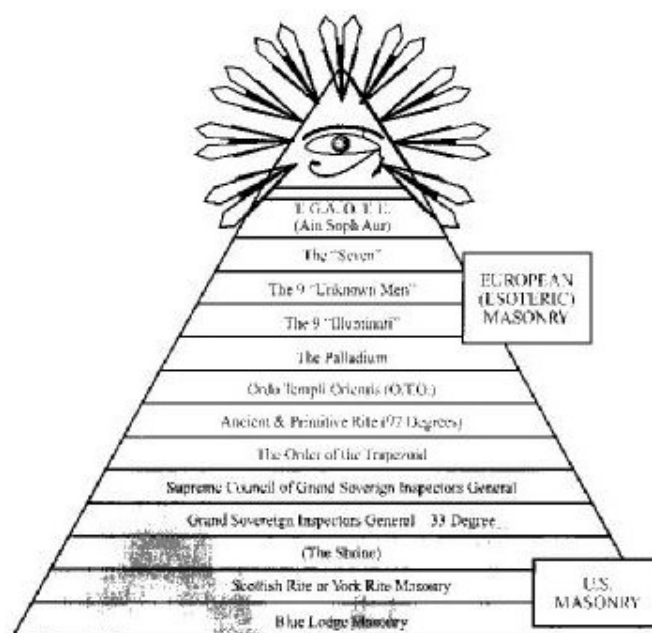

The Masonic Hierarchy

PYRAMID SHOWING VARYING DEGREES IN FREEMASONRY

CHAPTER FIVE

Freemasonry and litigation

In the Masonic Handbook page 183 to 184 we read that:

"Whenever you see the grand hailing sign... be sure not to bring the Mason guilty.... if you cheat or wrong any other, the government even, Masonry cannot and will not touch you... Conceal the crimes of your brother Masons. shield him. Prevaricate, don't tell the whole truth in this case, keep his secrets, forget the most important points. It may be perjury to do this, it is true, but you're keeping your obligations, and remember if you live up to your obligation strictly, you'll be free from sin"

Masons are sworn to persecute unto death anyone who violates Masonic obligation. In the oath of the *THRICE ILLUSTRIOUS OF THE CROSS*¹¹, the candidate swears, as follows: -

*"you further swear, that should you know another to violate any essential point of this obligation, you will use your most decided endeavors, by the blessing of God, to bring such person to the strictest and most condign punishment, agreeable to the rules and usages of our ancient fraternity; and this, **by the pointing him out to the world as an unworthy vagabond, by opposing his interests, by deranging his business, by transferring his character after him wherever he may go, and by exposing him to the contempt of the whole fraternity and of the world, during his whole natural life.**"*

The late Stephen Knight, a famous British journalist, wrote a book entitled "THE BROTHERHOOD" in which he clearly set out the way in which unscrupulous Masons destroy someone's life. Following a comprehensive information gathering campaign conducted through the formidable Masonic Network we read on page 147 how a Masonic Target is taken out.: -

Solicitors are very good at it, said Christopher. 'Get your man involved in something legal – it need not be serious – and you have him'. 'Solicitors', I was told, are "pastmasters" at causing endless delays, generating useless paperwork, ignoring instructions, running up immense bills, misleading clients into taking decisions damaging to themselves.

Masonic police can harass, arrest on false charges, and plant evidence. 'A businessman in a small community or a person in public office arrested for dealing in child pornography, for indecent exposure, or for trafficking in drugs is at the end of the line' said Christopher, 'he will never work again. Some people have committed suicide after experiences of that kind'.

¹¹ "Light on" eighth edition, page 199: as quoted in "The Character, and Practical Workings of Freemasonry" by Rev. C.G. Finney pages 102, 103 and 106

'Masons can bring about a situation where credit companies and banks withdraw credit facilities from individual clients and tradesman, said my informant. Banks can foreclose. People who rely on the telephone for their work can be cut off for long periods. Masonic employees of local authorities can arrange for a person's drains to be inspected and extensive damage reported, thus burdening the person with huge repair bills; workmen carrying out the job can 'find' – in reality 'cause' – further damage. Again, with regard to legal matters, a fair hearing is hard to get when a man in ordinary circumstances is in financial difficulties. If he is trying to fight a group of unprincipled Freemasons skilled in using the "network" it will be impossible because Masonic Department of Health and Social Security and Law Society officials (see pp 189-90) can delay applications for Legal Aid endlessly. 'Employers, if they are Freemasons or not, can be given private information about a man who has made himself an enemy of Freemasonry. At worst he will be dismissed (if the information is true) or consistently passed over for promotion'....

'Only the fighters have any hope of beating the system once it is at work against them,' he told me. 'Most people, fighters or not, are beaten in the end, though. It's...you see, I ... you finish up not knowing who you can trust. You can get no help because your story sounds so paranoid that you are thought a crank, one of those nuts who thinks the whole world is conspiring against them. It is a strange phenomenon. By setting up a situation that most people will think a fantasy, these people can poison every part of a person's life. If they give in they go under. If they don't give in its only putting off the day because if they fight, so much unhappiness will be brought to the people around them that there will likely come a time when even their families turn against them out of desperation. When that happens and they are without friends wherever they look, they become easy meat. The newspapers will not touch them'.

'There is no defense against an evil which only the victims and the perpetrators know exists.'

The City Police openly favour Masons under the Criminal Act. From document no Doc 279E Standing Orders (P.N. 501/80) for the Regional Development (Greater Durban Metropolitan area) Durban Regional of Business 39 Feld Str

Under Section 57 of the Criminal Procedure Act, 1977

(18) Members of the Force shall belong to no political or secret society, except those of Freemasons, Good Templars or other recognized Friendly Societies. It is also provided that they may be members of any municipal trade union recognized by the City Council. (P.N. 92/81)

REPORT

of the

COMMISSION OF ENQUIRY INTO SECRET ORGANISATIONS

Published by Authority

REPUBLIC OF SOUTH AFRICA

R.P. No. 20/1965

ADMINISTRATIVE IRREGULARITIES IN THE JUDICIAL SYSTEM AND ACTIVITIES BY MEMBERS OF SECRET SOCIETIES

"Drawing from PENNY SLIMMER NUMBER 103. Reprinted by Permission"



THE SPOILSPORT, OR, THE CULPIT WHO ADMITTED EVERYTHING.

BY: IZAK H. LABUSCHAGNE

Freemason on bench sparks judicial uproar

By CARMEL DEKARD

THE disclosure by a Supreme Court judge that he is a member of the Freemasons has rekindled controversy over whether judges should retain membership of secret societies once they are appointed to the bench.

Presiding in the Rand Supreme Court last week, Mr Justice Tebo Coetzé referred himself from a case where the matter of secret societies and their possible influence on judges or lawyers was an issue. He asked former businessman Isak Lubachague, who appeared before him on behalf of the African Christian Democratic Party, which secret societies were allegedly involved. When Mr Lubachague said he was referring among others to "Catholistic Jews and Freemasons", Judge Coetzé disclosed that he was a Freemason and would therefore arrange for another judge to hear the matter.

Speaking after wards, Mr Lubachague said it was important that judges be seen to be "a hundred percent impartial". If they were part of a secret society they should not be appointed to the bench. He said he suspected many judges were members of secret societies but few of them disclosed the fact.

Judge Coetzé's disclosure has led to

strong responses from one, here, of the best human rights lawyers, the Association of Law Societies and other members of the profession who say it is inappropriate for judges to belong to any secret organisation, whether the Brethrenhood, the Freemasons or any other, and that they should be ineligible for judicial appointment if they refuse to give up membership.

However, Transvaal Judge President Frikke Bluff appears not to share this view. Referring to a recent statement by the Lord Chancellor of England, that he could see no conflict between membership of the judiciary and of the Freemasons, Judge Bluff said he agreed with Lord Mackay.

Justice Minister Dullah Omar said it had to be asked whether membership of secret societies did not undermine the impartiality and independence of the judiciary. "If it does, something will have to be done about it."

Asked for comment, Chief Justice Mick Cautel had not yet replied at the time of going to press.

The matter surfaced in public three years ago when it was heard that Mr Justice Willem Booysse of Natal was a member of the Brethrenhood. In the subsequent column, the judge resigned from the organisation and its executive.

Following this incident, the General Council of the Bar and the Johannesburg Bar Council took a strong stand against judges retaining membership of any secret organisations.

Current chairman of the GCR Malcolm Wallis SC said no-one should leave court wondering whether the judge was in any way influenced by membership of a secret body.

Association of Law Societies' president Tony Brady said his organisation stated this position. The Legal Resources Centre urged that the Minister of Justice call on all judges to declare whether they belonged to any such society, and then to choose between the bench or the organisation.

Judge Coetzé, an attorney in Lydenburg until the end of this week, was asked, through his clerk, for comment. However, there has been no response. Instead, Gerald Yalungkie, district Grand Master of English Freemasonry in the Transvaal, contacted the Sunday Times.

He said the principles of Freemasonry would require any judge who was a member to put the impartial administration of justice above any undertaking to assist fellow Masons, and hence about a judge's impartiality were therefore groundless.

Hospital kit to be audited

By VVETIE van BRHDA

LIFE-SAVING hospital equipment is to be examined in a national audit in an attempt to solve the "crisis" in maintenance.

The South African Association for Clinical Engineering is lobbying for legislation to govern the maintenance of medical equipment and for people who repair the equipment to be registered.

The need for legislation has been highlighted by a recent Cape Town Supreme Court finding that a private hospital was negligent as it did not have a working defibrillator on hand to revive a patient when her heart failed. The half-hour delay in restoring Rosemary Lloyd-Roberts' heartbeat led her with brain damage.

Vincent Marrewaer, a spokesman for Health Minister Dr Nkomo's team, said a new directorate of Health Facility Planning has been set up to tackle the problem.

The department would carry out an audit of equipment maintenance.





7 November 1994

The Minister of Justice
Mr D. Omar
Houses of Parliament
Cape Town
8001

Dear Sir

re: Isak Hermanus Labuschagne

Over a period of about 3 months the aforementioned person has sent voluminous correspondence to me. I have also met the gentleman on two occasions. During those occasions I discussed his affairs with him at some length.

Mr Labuschagne is involved in a series of very complicated civil cases in Durban both in the Supreme Court and in the Magistrate's Court.

He makes allegations which, in some respects, are backed by irrefutable evidence that go to the very root of the integrity of the system of justice in Natal. In these circumstances the writer has felt that he should refer this matter to you as you are the officer responsible for the implementation of justice in our country. Implicit in Mr Labuschagne's complaint is the influence of a secret society known as the Freemasons whose members according to Mr Labuschagne have hatched a deliberate plot to ruin him. Members of this society, according to Mr Labuschagne include judges, advocates and attorneys. The said gentlemen, according to Mr Labuschagne, are consciously doing everything, using every technique in the book to prevent Mr Labuschagne receiving the justice that he feels is his due.

According to Mr Labuschagne his problems arose when he learned that he had been inducted by his father into Masonry from his birth and he decided to resign from the society by writing a letter of resignation to the responsible officer of the society.

Apparently members are not permitted to resign from the Freemasons. Very serious consequences flow from resignation or from revelation of the secrets of the society. To this end Freemasons swear quite frightening oaths by which they undertake to perform the most frightful acts against Masons who have strayed from the teachings of the society. I attach hereto a sample of the various oaths gleaned by Mr Labuschagne from various sources.

I attach hereto a document entitled "Report on Masks" drawn by Mr Labuschagne which sets out the beginning of the actions taken against him. The document makes disquieting reading at least.

There were further actions taken against Mr Labuschagne. I attach hereto a copy of a report entitled "Report on Administrative Irregularity among Jurists" drawn by Mr Labuschagne dated 21/10/94.

I also attach copies of an affidavit and a supplementary affidavit in case no A 175/93 instituted in the Durban and Coast Local Division. I also attach Mr Labuschagne's "Report on Administrative Irregularity among Jurists" dated 26/10/94.

One cannot assume that Mr Labuschagne, being a party in the proceedings as well as being an unrepresented, is correct in all his allegations. But at least some of the events recounted do raise a suspicion. What Mr Labuschagne also fails to mention is that he has been denied legal aid. In the circumstances of this case I would have thought that the grant of legal aid is an absolute necessity.

I request the Minister to look into the matter urgently.

Thank you

Yours faithfully



Senator E.S. Mchunu



Here is how to 'work the tools' in order to 'unveil the mystery' of the 'symbolism'.

By referring to the diagram of the court room below:

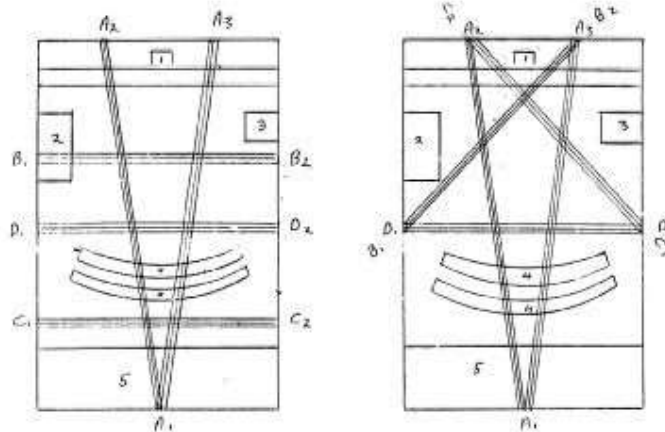
Move line B1-B2 to lie from D1 to A3 and line C1-C2 to lie from D2-A1.



Legend

- | | | |
|---------------------|---------------------|-----------------|
| 1 - Judges seat | 2 - Assessors bench | 3 - Witness box |
| 4 - Counsel's bench | 5 - Gallery | |
- 6 - A1-D2 - wires strung halfway between the ceiling and the floor to dampen the echo in the room. Any sound engineer will say that that is a highly inefficient way of solving such a problem.

The result is a pentagram. Place 'Mendes' inside the pentagram as is the custom, and you have:

- 1 the horns located over the judge,
- 2 one ear next to the assessors bench
- 3 another ear next to the witness box,
- 4 the mouth over the counsel's benches and
- 5 the beard in the gallery.

Coincidence?

Please consider this:

- 1 The Supreme Court building stands on Masonic Grove,

try's first sailing restaurant, due to open its doors ... well, gang-planks, this week on Durban's bay.

"Initially we were planning to start as a floating restaurant with a very personalised service for groups of up to eight people. Then we decided what the heck, if people want to sleep over, we might as well go the whole way and also have a hotel as we have three luxury cabins.

"A visiting group of businessmen, for example, can fly in from Johannesburg or overseas and for far less than the price of a beachfront hotel get a cabin, an a la carte meal, breakfast and a sail around the bay.

"Sweet Waters is a traditional cruiser with a lot

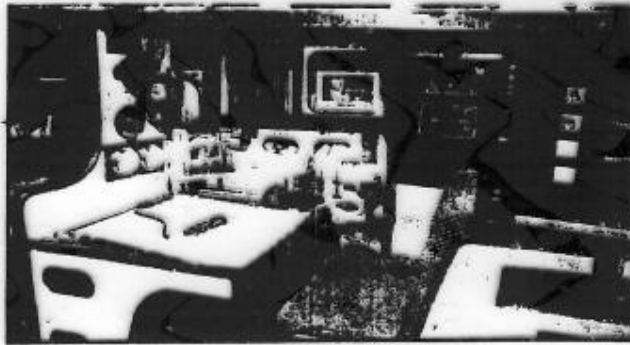

High-tech navigation table.

of character, and we want everything to be in the gracious old-world style of yachting. All wooden fittings are made from teak and yellow-

wood salvaged from old Durban hotels, but at the same time we have First World comforts like a laundry, hot showers and the most modern naviga-

tional and safety equipment on the market. There're also two TV sets and a music studio."

Sweet Waters is a well-known ketch in cruising circles and rugged in the extreme. Built by the Wadsworth family from Amanzimtoti (hence the name Sweet Waters) in the '70s, Donald Wadsworth said when they launched it they would be prepared "for any eventuality". The fibreglass hull is 20cm thick in places.

In 1986 the boat was sold to another South African, Phillip Theron, who bought it on condition it would be delivered to him in Spain - with a R20 000 penalty clause if they were late.

The delivery voyage turned out to be an epic saga of survival. Donald Wadsworth and his sole crew member were hit by Hurricane Klaus off St Martin Island and for three days they were smashed by 15m waves and winds screaming at 120km/h. Wadsworth believed the ship was lost for hours, while his German crewman, a sailor, claimed agnostic and a crucifix and prayer. They were blown 200 nautical miles off course - and had to forfeit the R20 000 penalty for being late.

Almost the entire fleet moored at St Martin was destroyed, but the only damage to Sweet Waters was two broken halyards - one of the few yachts ever to have survived a hurricane out at sea.

"She is one tough boat. In fact, after surviving all that she must be virtually indestructible," said Mr Lathuschagns.

But at the moment she will be used for more sedate things. We won't even go out of the harbour during dinner unless asked by clients.

Sweet Waters charters will be operating from Wilson's boat-yard.

FINAL PUBLIC AUCTION FINAL

SMUGGLED GOODS DESTINED FOR USA REDIRECTED TO NATAL DUE TO CUSTOMS SEIZURE OF IRANIAN MERCHANDISE

MASSIVE LIQUIDATION — WITHOUT RESERVE AT GRINDROD CARGO SERVICES DURBAN

Resulting from deterioration in USA/Iranian relations and current embargo on Iranian goods — 14 bales of Iranian and Oriental rugs re-directed to R.S.A. on S.A Winterberg Bill of Lading No. 625587 to be sold by public auction to pay pending fines and penalties imposed on U.S. Importer by U.S. customs.

PERSIANS, AFGHAN, TURKISH, CHINESE, RUSSIAN CARPETS, RUGS & RUNNERS OF ALL SIZES

FINAL BALES OF PERSIAN & ORIENTAL CARPETS & RUGS

EXAMPLES: Afghan, Belouch, Hamadan, Karachi, Silk Quorn, Isfahan, Islamabad, Kazak, Khellims, Chinese, Saddle Bags, Mori Bokhara runners, large carpets, all of a high investment standard

FINAL SALES TAKE PLACE AS FOLLOWS:

SUNDAY 7th JUNE AT 11.00 am
SUNDAY 7th JUNE AT 2.30 pm

VENUE: WAREHOUSE, MESSRS GRINDROD CARGO SERVICES 34 SHADWELL RD. CNR. JOHNSTON RD. MAYDON WHARF, DURBAN

Every item will be sold individually. This is probably the finest selection of investment quality rugs ever to be sold by public auction. As goods are sold and relevant payments made by ourselves, further funds will be released to us for auction.

VIEW: 1 HOUR PRIOR TO EACH AUCTION TO MINIMISE DISRUPTION OF WAREHOUSE

FORM OF PAYMENT: C.D. WITH ALL PERSONAL CHEQUES UNLESS PRIOR ARRANGEMENTS MADE WITH AUCTIONEER AT SALE. VISA & MASTERCARD CARDS ACCEPTED SUBJECT TO APPROVAL

AUCTIONEER'S NOTE: EVERY ITEM SOLD WITH CERTIFICATE OF AUTHENTICITY AND INSURANCE VALUATION

AUCTIONEER: M. SWANEPOEL

...with
ser-
up to
we de-
heck. If
to sleep
as well go
way and also
as we have
ury cabins.

...sitting group of
ssmen, for exam-
can fly in from
urg or overseas and
far less than the price
a beachfront hotel get
cabin, an a la carte
al, breakfast and a
around the bay.
Sweet Waters is a tra-
ditional cruiser with a lot

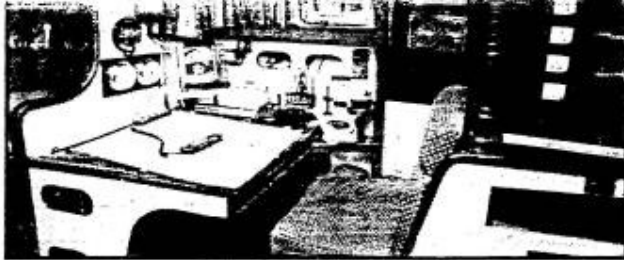

High-tech navigation table.

of character, and we want everything to be in the gracious old-world style of yachting. All wooden fittings are made from teak and yellow-

wood salvaged from old Durban hotels, but at the same time we have First World comforts like a laundry, hot showers and the most modern naviga-

tional and safety equipment on the market. There're also two TV sets and a music studio."

Sweet Waters is a well-known ketch in cruising circles and rugged in the extreme. Built by the Wadsworth family from Amanzimtoti (hence the name Sweet Waters) in the '70s, Donald Wadsworth said when they launched it they would be prepared "for any eventualty". The fibreglass hull is 20cm thick in places.

In 1986 the boat was sold to another South African, Phillip Theron, who bought it on condition it would be delivered to him in Spain — with a R20 000 penalty clause if they were late.

The delivery voyage turned out to be an epic saga of survival. Donald Wadsworth and his sole crew member were hit by Hurricane Klaus off St Marten Island and for three days they were smashed by 25m waves and winds screaming at 120km/h. Wadsworth helmed non-stop for 48 hours, while his German crewman, a self-proclaimed agnostic, held a crucifix and prayed. They were blown 900 nautical miles off course — and had to forfeit the R20 000 penalty for being late.

Almost the entire fleet moored at St Marten was destroyed, but the only damage to Sweet Waters was two broken halyards — one of the few yachts ever to have survived a hurricane out at sea.

"She is one tough boat. In fact, after surviving all that she must be virtually indestructible," said Mr Labuschagne.

"But at the moment she will be used for more sedate things. We won't even go out of the harbour during dinner unless asked by clients."

Sweet Waters charters will be operating from Wilson's boat-yard.

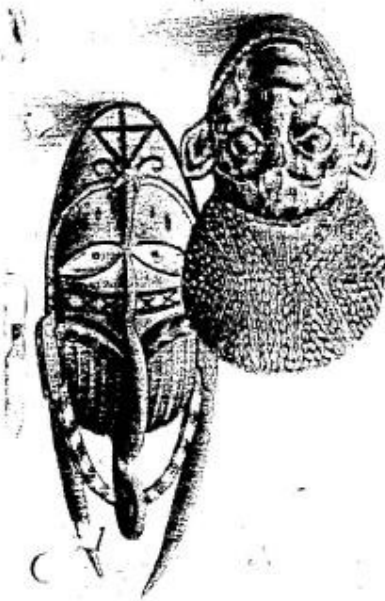

add cut out (see overleaf)

and masks inserted in

Court papers

For my sequestration.

(Note triangle over mouth —

masks are upside down)



SOME OF OUR LATEST FEATURES

KENYA, EGYPT, ZAMBIA, ANGOLA ...

For four consecutive years, South African Airways has been voted "Best Airline to Africa" by readers of the U.K.'s prestigious *Executive Travel* magazine. Which is certainly something to smile about. In the same tradition, we now offer more convenient flights to a growing network

of African destinations. Each with the same uncompromising standards you've come to expect from SAA. Unrivalled inflight service. Truly memorable hospitality. Mouth-watering cuisine. And fine wines. You'll find all the above, and more, wherever we make an appearance.

Destination	Days of week
Johannesburg • Windhoek	Mon, Tues, Wed, Thurs, Fri, Sun
Cape Town • Windhoek	Fri, Sun
Johannesburg • Maputo	Mon, Thurs, Fri, Sun
Johannesburg • Lilongwe	Mon, Thurs, Sat
Johannesburg • Maputo	Sat, Sun
Durban • Mauritius	Sun
Johannesburg • Lusaka	Wed, Sun

Destination	Days of week
Johannesburg • Nairobi	Fri, Sun
Johannesburg • Harare	Mon, Tues, Wed, Thurs, Fri, Sat, Sun
Johannesburg • Bulawayo	Mon, Thurs, Sun
Johannesburg • Victoria Falls	Sat
Johannesburg • Luanda*	Mon, Thurs
Johannesburg • Cairo	Wed

Schedules subject to change

*In association with TAAZ-Angola Airlines.



YOU 5 November 1992

69

LINDSAY SMITHERS-FCB 8800

there was registration of marks more than five hundred years ago. Curiously, that too was in Scotland.

In a speculative Mark Lodge every Brother selects the mark by which he is afterwards to be known, and this mark is enrolled and registered in the books of his own lodge, and also in the General Register Books of Marks in the Mark Grand Lodge. It is usual for such marks to have a geometrical character, and to consist for the most part of straight lines and angles.

The rise of the craft guilds in England and other countries appears to have intensified the need of craft marks, not only the masons'. There was great industrial activity of every kind in early mediæval days; the various countries were exchanging goods, merchants were growing rich, their wealth was finding its way into the coffers of King and Church and noble, buildings were being erected—churches, abbeys, castles, bridges—and the number of men employed as masons must have steadily and quickly increased generation by generation. In all probability the only masons on any building who could read and write were the Master Mason and perhaps an overseer or two. The rest could indicate their identity only by means of a simple mark, easy of invention, still easier to adapt from an earlier one. There are certain marks that a man with a mason's axe or hammer and chisel will instinctively make, and such are the marks that we find repeated again and again over thousands of years.

The study of any comprehensive lists of marks, such as those, for example, to be found in *AQ.C.*, vol. lviii, and in these pages, will reveal that over and over again the marks are such as can be extremely easily executed—in fact, made in a few seconds by the application of very simple tools. We find the same marks or types of mark used in many places, with of course infinite variations to please the fancy of the individual mason. Curves are comparatively rare, neither the tools of the mason nor the material on which he worked favouring the easy or natural production of a curved mark. There are probably a hundred straight marks for one curved one. Most of the marks are extremely obvious and many of them originated with two lines forming a cross, so: + or X, from which basis can be built easily and simply all sorts of figures.

Such an authority as Wyatt Papworth considers, with many other writers, that mason marks "often took the place of a proper signed manual to a document; they designated the stone which each man worked and pointed out instantly who was responsible for defect or mistake." The marks were generally put on the face of the stone near one of the edges, so that they remained exposed when the stone was built into the wall;

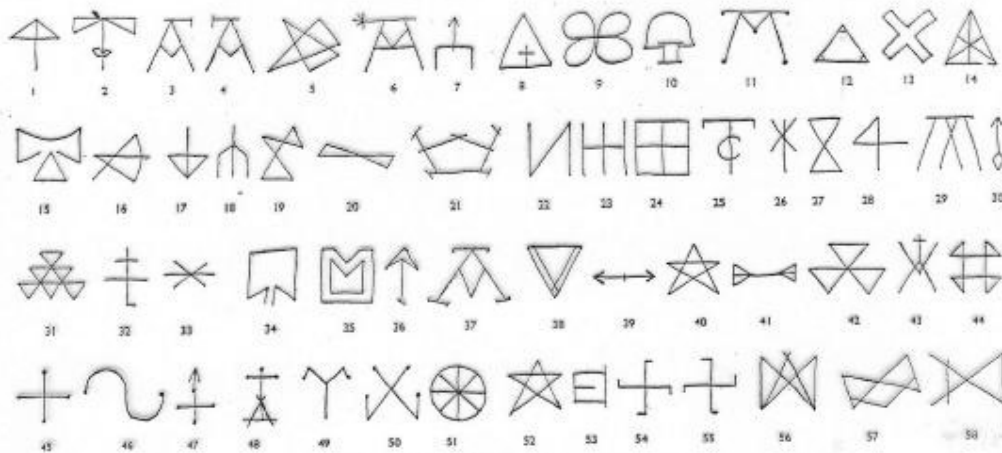

MASON MARKS, ENGLISH

1-7, Selby	17-20, Herwell Church	35-37, Ely Cathedral
8-10, Canterbury	21, Whitby	41-51, Bridlington Priory
11, Guisborough	22-30, Stonyhurst College	52-55, Bidsron Old Hall
12-14, St Mary's Abbey, York	38-44, Birkenhead Priory	56, Bromborough
15-16, Halmacker, Sussex	31-33, Raby Water Mill	57-58, Sussex

Izak Labuschagne

Suite 605(11), 331 West Street,
P O Box 3966, Durban, 4000,
Tel (031) 3071434

E-mail izaklab@netactive.co.za

Website: <http://www.skyboom.com/hermon>

NSW Dealers Representative No S.I.25015 (ACIP) (IAFP)

Thursday, 09 November 2000

The Honourable Judge Shabalala
Judge President
High Court of South Africa
Durban and Coast Local Division

CC

Mr. Malcolm Hartwell
Deneys Reitz Attorneys (Attorneys for the defendant)
The Marine, Gardiner Street,
Durban

Dear Sir,

RE: LABUSCHAGNE V D WARNE AND ASSOCIATES (PTY) LTD - CASE NO 5447/96

Rule 376(e) – the question of transference of the matter to another court

The purpose of this correspondence is to determine whether an application should be made in terms of Rule 37 6(e) for the matter to be transferred to another court, since this issue was raised at a Rule 37 conference held on 25 October 2000 in the chambers of adv. Gordon SC.

Your lordship is no doubt aware that *sometimes controversy develops around litigation which can make it difficult and sometimes even impossible for certain presiding officers in a jurisdiction to act in such matters. When care is not taken in such instances, review proceedings might ensue*¹² which serves little to manage the controversy. Whilst this is unfortunate, it is perhaps in this case not a bad thing in itself because it could serve only to bolster the idea that *old practices and ancient formulae must be modified in order to keep touch with the expansion of legal ideas, and to keep pace with the requirements of changing conditions*¹³. I say this because this particular case is interlaced with **two basic controversies**. The one centres around **Secret Societies** such as Freemasonry and the

¹² See address of Chief Justice Ogilvie at the centenary celebrations of the Northern Cape Division of the Supreme Court wherein he stated that that Judges must avoid creating an impression that may be construed as evidence of some sort of prejudice, however unintentional that may be. See also the UN - *Basic Principles on the Independence of the Judiciary*; as adopted by the Seventh United Nations Congress on the Prevention of Crime and the Treatment of Offenders, held at Milan from 26 August to 6 September 1985 and endorsed by General Assembly resolutions 40/32 of 29 November 1985 and 40/146 of 13 December 1985 http://www.unhchr.ch/html/menu3/b/h_comp50.htm

¹³ Per Innes J in *Blower v Van Noorden*, 1909 TS 890 at 9p905

other around the current world wide reformation¹⁴ against **undue legalism, technicalities and formalism and unethical conduct** in proceedings. As we all know the aim of this reform is to bring systems of justice in line with the populis' fundamental rights to *equitable access to court* and *fair legal proceedings* once the courts are seized of a matter.

Secret Societies and organizations Freemasonry.

Durban has for many years been well known among Freemasons as **a friendly Masonic Port**, to the point that this is **reflected in law**, in that under clause 18 of P.N 92/81 for the Durban City Police which falls under section 57 of the Criminal Procedure Act we read that **Members of the force shall belong to no political or secret society, except those of Freemasons, Good Templars and other recognised friendly societies.** Whilst my father was the head of the Freemasons in 1977, I refused to join when I was told by Port Authorities in Durban that it would be all but impossible for me to operate yacht charters in the harbour without being a member.

I have attached a summary of the Masonic and related oaths hereto under **annexure "A"** (and on) in order for your lordship to gauge the obvious problems with regard to them presiding in matters where their members are represented. www.skyboom.com/hermon/index28.html

Following a letter of concern to the Judge President of the time his **lordship Judge Howard** In 1995 he allocated **Judge Mall** to my matter, before whom I then proceeded to place an application in which I proved on a balance of possibilities that there was a conspiracy and wherein I was subsequently granted leave to take steps to set up a Commission of Inquiry into the conspiracy. This **commission** was stifled by members of Masonic related organizations¹⁵ and now exists as an *actio popularis* commission as described in **annexure "C"** attached hereto and on www.skyboom.com/hermon/index6.html

In line with those oaths and with a deadly accuracy in respect of Stephen Knights summary in annexure "A", this action which I have before this honourable court at this time was subjected to a **stifling campaign** that has involved no less than six supreme court cases backed by some 10 litigants, 9 of whom were Freemasons or had strong links with that society.

It took me **six years** of acting for myself (simply because lawyers were being coerced away from me – see **annexure "D"**) under very difficult circumstance, to overcome each of these six cases by having the orders set aside and rescinded as the case may be, the last of which was finalised in the first half of this year. I could then turn my attention to the original case, which is now set down for **trial on the 20th to 21st of November 2000.**

¹⁴ Wolf Commission (UK) Danish Transitional Council (RSA), Irish department of Justice and legal reform. The Century Foundations International task force "Making Justice Work"; The Law Commission of England and Wales, Australian law reform Commission to name but a few.

¹⁵ Minister Dulla Omar was a member of the ANNMS, Chief Justice Corbett was a member of the Order of David. Shortly after Senator Mchunu's death these two, as the leading members of the JSC quickly stifled any investigation by the JSC into the issue.

Reports regarding this issue were made to the **Senate**, and the **Judicial Services Commission** (JSC). Overseas, several Commissions adopted the same stance and the issue has been well aired in the media. These reports eventually convinced the JSC's (especially the 13 new members appointed in 1998-98) to questioning of Judges about their affiliations to secret societies, especially Masonry.

Nevertheless, I have experience extreme reactions from Judges when just mentioning the Masons in court. A Judge of this division went so far as to call the senate insane in open court whilst another had the integrity to apologise for his behaviour toward me.

In the month leading up to the elections of the Judge President of this division I was subjected to a vicious **campaign designed to discredit** me in order that the objections against Masonic jurists which I had raised, loose their impetus, as should clearly emerge from **annexure "D"**¹⁶ attached hereto.

Unethical conduct by officers of court

During the course of the last six years, I have been repeatedly subjected to techniques in litigation and conduct in proceedings, which have been considered highly unethical by many authorities, officers of court, jurists, attorneys, advocates, members of Parliament, Senators and other dignitaries. So serious were these developments that a Senator who was also a **member of the Judicial Services Commission**, the late **Senator, Prof Ernst Mchunu** went so far as to write to the Minister of Justice, Mr. Dulla Omar stating that I had **produced irrefutable evidence that goes to the very root of the integrity of the system of justice in Natal.**

I attach hereto a copy of a letter under **annexure "B"** which will serve to illustrate some of the problems I had with just one legal firm and their counsel.

In this respect, I must point out that I have noted **Review proceedings** against the judgment of **Judge Patel** as it relates to the incident described in that letter. Judge Patel did not deal with any of the precedent raised. Moreover, having regard to the fact that the judgment was handed down one month to the day before the hearing of this matter, in the final month of the election for the Judge president of this division, a whole year after the hearing from which it arises, and as such, at the height of the campaign related in annexure "D", one can only assume that he was influenced by the campaign in his judgment. More so because of the fact that it is well known that only well connected advocates get work from the larger firms of insurance underwriters, with mandates to stretch the litigation out and thereby stifle any opposition. The actuarial calculations employed in this are now legend in the industry – hence the need for reform. The select few advocates that do this type of work make between 3 to 5 million a year in fees. No doubt an enormous amount of money is involved in reductions in fees for this type of litigation, should it become outlawed. It stands to reason that these advocates will strenuously lobby support from the Judges (as they often do), either directly or indirectly. In this case, I have proof, which I shall present at the review proceedings, since that

¹⁶ See also UN - **Basic Principles on the Role of Lawyers** as adopted by the Eighth United Nations Congress on the Prevention of Crime and the Treatment of Offenders, Havana, Cuba, 27 August to 7 September 1990. http://www.unhchr.ch/html/menu3/b/h_comp44.htm

application will contain an application that it proceeds by way of trial, given the fact that I will need to present evidence provided *viva voca* by officers of court, in camera, in order to protect their interests.

Furthermore, it is well known among lawyers that I have been very involved in the movement to reform the system of justice in that respect, in that I have had contact with several organizations such as the Danish Transitional Council in South Africa and others listed in the footnote on the first page. It is also known that I head up the Justice 2000 initiative of SADC Development Fund Trust, the details of which appears on the Web Page www.skyboom.com/hermon/index7.html

Reports are with the **Judicial Services Commission** relating how Judges have refused me the record of proceedings and one even caused the record to be destroyed. I have been subjected to contradictory rulings and gross irregularities and even grossly defamatory statements made by Judges in their judgments. In one case 204 pages of evidence was removed by my opposing attorneys from a court file in an application for my sequestration (which was eventually set aside). In that application it turned out that the presiding Judge, **Judge P C Combrinck** was actually on a subcommittee of a yacht club making up the mooring organisation, which was one of the parties before court in one the cases used in the conspiracy related to Judge Mall. Judge Combrinck was taken on review, but since the sequestration was set aside under section 54(5) of the Insolvency act, it is no longer necessary for me to peruse that avenue.

Judge Hurt shared chambers with adv. John Pammenter and handed down a Judgement in Case A175/93 in which Pammenter acted against me and which judgment was severely criticised by various prominent authorities in South Africa. This judgment has all the earmarks of a judgment wherein the Judge went out of his way to look for every technical reasons to justify a particular outcome. It also contained statements which I consider grossly defamatory. My rights against him in respect of defamation are reserved and I intend to bring him to book for his statements, once I have finished with the current case.

Judge Squires acted as if papers were missing off my court file in a matter wherein John Pammenter was the counsel when he realised that Pammenter was not in court. He sent me off to the Registrar to find the supposedly missing papers and to return after the tea break. After the tea break Pammenter arrived in court apologising for being late and stating that he was only just then briefed to appear. The papers had in the meantime miraculously appeared on the court file. This incident forms part of a report to the Judicial Services Commission.

Judge Mc Larren, refused to let me have the record of proceedings which lasted four days and in which he contradicted himself in his rulings on no less than 3 occasions. The proceedings for review against his judgment are still held up due to the fact that I still cannot get hold of the record of proceedings. It has all along been my intention to also seek leave to sue him for the grossly unfounded, false and defamatory statements he made in his judgment. Adv. Pammenter was also involved in this case. Incidentally **adv John Pammenter is a prominent Mason** who also became the **chairman for the society of advocates in Durban**.

Acting Judge Puckrin of the TPD actually caused the record of proceedings to be destroyed in a matter wherein I intervened to place evidence before court that NI had infiltrated *the St. John's Apostolic Faith Mission church*. Puckrin JA was also a Freemason.

Rhetoric is strenuously propagated that I am satisfied with no Judge that rules against me. This is not so, as I have appeared before many Judges in seven years as may well be appreciated. Over the last seven years I have appeared in court all over South Africa, as I needed to intervene in the public interest in terms of section 38 of Act 108/96. Some of those Judges and magistrates ruled against me and some ruled for me. In some cases, I was openly complemented by Judges for my actions, in one case, even when I lost the application¹⁷. These Judges are not all mentioned in this because they behaved as Judges should and deserve the respect that such Judges deserve. Just because I do my duty¹⁸ in exposing corruption, misbehavior and such actions as would bring the system into disrepute, does not deserve the factious comments that make up the rhetoric I referred to earlier.

Requests

Accordingly, I hereby respectfully request that your lordship: -

1. will be pleased to make every endeavor to ensure that the Judge allocated this case is not a Freemason, or one that controls, or sympathises with Freemasonry, or one that is a member of any other secret society. A list of related organizations appears at the foot of **annexure "A"**. A more comprehensive report regarding this issue appears under **volume 9** on the file of **Case No A175/93**.
2. Will be pleased to allocate this case to a Judge that is not a sympathiser of the type of formalistic, legalistic and technical proceedings that is now generally becoming outlawed worldwide, since it infringes on the right to equitable access to court and fair treatment in the system of justice.

Judges available on 20 – 21 November 2000

I understand that the following Judges will be presiding around the 20th to the 21st of November.

Judge Hurt, Judge Pillay, Judge Squires, Judge P C Combrinck., Judge Booyens

In this respect, Judges Hurt, Squires and Combrinck are discussed above.

I have never appeared before **Judge Pillay** and have no idea what his connections may or may not be, neither do I have any inkling as to whether he subscribes to the type of formalism that is now being outlawed worldwide.

¹⁷ Judge Golstein, WLD in Labuschagne v SABC 1996

¹⁸ SALJ May 1994 page 268 centre per R Goldstone; Froneman J in Matiso v Commanding Officer, Port Elizabeth Prison and another 1994 SA (4) SA 592 (SECLD) 594 at F; Corbett CJ in Argus Printing & Publishing v Esselen's Estate 1994 (2) 1 (A) at 25 -8

Judge Booyens is well known as having been a member of the Afrikaner Broederbond. Many members of the Broederbond were also members of the Freemasons in latter years. I have no idea where his sympathies lie either.

I am sure your lordship will appreciate why I wish to bring my matters before this division to finality more than anything else. It has been a very long and difficult 7 years fraught with frustration and deep disappointment in some respects as well as the relief of finally having overcome all the cases against me. Should the campaign against me related in annexure "D" have developed to the point where I am considered by every jurist in this division in negative terms, then I am clearly on partisan territory because then these jurists are saying the they alone are right in my character assessment and the rest of the world (see list under annexure "D") are all wrong, and this just cannot be. In that case, I must apply to have this matter heard elsewhere. However, I would dearly want to avoid all that your lordship. I sincerely pray, sir, that with the advent of your appointment, the strongholds that have beset this division can be broken and that steps can be taken to remove the stain that those strongholds have left in this division's record of conduct. I pray too sir, that bold steps are taken to embrace the moves to reform the system to a more accessible and fair system. I pray that my matters will now reach finality.

As your lordship will note, this letter has been copied to my opponents.

Yours faithfully,

Izak Labuschagne

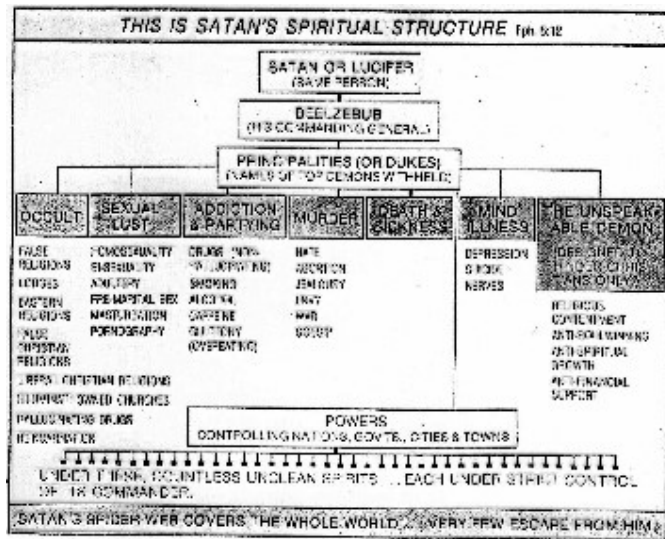

CHAPTER SIX

Brainwashing Techniques

Brainwashing is not a new concept. It was used **during both World Wars, Korea, Vietnam, The Gulf War**, extensively in the **USSR**, and in the context set out in the heading to this report in the **South West Africa (SWA) Boarder War** conducted by South Africa in the 70's and 80'. It is used extensively today by various agencies such as the **Tri Lateral Commission (TLC)**, **The Council on Foreign Relations (CFR)** and various UN agencies such as the **United Nations Peace Corps (UN PC)** in order to assist with ***brokering peace amongst conflicting nations and communities, fostering democratisation in authoritarian regimes, and in counteracting religious extremism.*** It is conducted through various mediums such as **direct contact, training camps, media exposure, radio broadcasts, religious services, primary, secondary and tertiary education** and even ***Biological Aids*** (mostly added to drinking water, foodstuffs and medication. The Science of ***Social Automation Technology*** is highly developed today and makes use of extensive computer hardware and software that was developed both in the **NATO and the Warsaw Countries**. In fact, the **USSR** are leaders in fields such as ***Computer-Generated Emotional Mind Mapping.***

Just prior to the 1994 elections the national media¹⁹ disclosed how **Dr. Johan Van Der Westhuizen** was running an MI front organisation called **Adult Education Consultants (AEC)** in Soweto under the orders of **Joffel Van der Westhuizen (MI chief at that stage)** and **Tertius Delport Minister of Agriculture in the Western Cape**. This group was to install (through ***Adult Education***) a ***cultural shift in the community that would bring about a drop in township unrest in order to ensure a smooth transition of power to the ANC.*** Van Der Westhuizen had also infiltrated the African Christian Democratic Party²⁰ which was to serve as the future home of the NP under a moderate black leadership, that would be coaxed into the Masonic Fraternity in order to ensure ***cohesion and security of the central mandate*** (especially once the massive overseas funding planned for the project got underway).

During the South African Boarder War, National Servicemen that were selected for duty in **Military Intelligence** were screened at **Voortrekker Hoogte** (where they did their security Clearances) and were then sent to **Grootfontein** in SWA where further screening took place. They then underwent a training course in **Windhoek** and later a more intense course at **Hartswater** in southern SWA. Once it was determined that they were able to successfully conduct training (brainwashing) they were sent to operational area headquarters (such as at **Katimo Mulilo in the Caprivi Strip** in northern SWA where it borders on Zambia, Botswana and Zimbabwe (Rhodesia then). Here they ran ***Agricultural Training Seminars*** which were designed as ***workshops***. Community leaders were first studied and then handpicked for the training workshops / Seminars (in reality highly researched and successful brainwashing sessions). At the seminars they were taught, ***life skills, skills in conflict management, stereotype reduction, social management skills*** in a very subtle yet highly manipulative interactive, ***perform and be rewarded type of workshop environment seminars.***

In 1983 for example, the officer in charge of the ***Katimo Mulilo Group*** was **Mc Sweeny**, assisted by psychiatrist **Costallo**.

1 ¹⁹Weekly Mail and Guardian February 1994

2 ²⁰BAM v ACDP Supreme Court Johannesburg Case No 94/25886

Training Manual No. TM-SW7905.1

Typical of the manuals developed for this type of operation was **Training Manual No. TM-SW7905.1**²¹ This manual is *entitled Silent Weapons for Quite Wars*, Therein the science of **Social Automation Technology** is succinctly set out complete with **Tables of Strategies** and a **list of Inputs and Outputs**: -

Under the *Historical Introduction* we read that *Silent Weapon Technology* evolved from **Operations Research** (O.R), a strategic and tactical methodology developed under **Military Management** in England during WW II...It was soon recognised by the **Council on Foreign Relations** as *an effective means of controlling society*.

In the *Formal Introduction* we read the following: -

The solution to today's problems requires an approach that is ruthlessly candid, with no agonising over religious moral or cultural values”, and as such must be ‘secured from public scrutiny”.

Under the heading, **Descriptive Introduction of the Silent Weapon** we read: -

Everything that is expected from an ordinary weapon is expected from a silent weapon by its creators, but only in its own manner of junctioning

It shoots situations instead of bullets, propelled by data processing, instead of a chemical reaction, (explosion); originating from bits of data instead of grains of gunpowder, from a computer instead of a gun; operated by a computer programmer instead of a marksman, under the orders of a banking magnate instead of a general.

It makes no obvious explosive noises, causes no obvious physical or mental injuries, and does not obviously interfere with anyone's daily social life.

Yet it makes an unmistakable “noise”, causes unmistakable physical and mental damage, and unmistakably interferes with daily social life, i.e., unmistakable to the trained observer, one who knows what to look for.

The public cannot comprehend that they are being attacked by a weapon, and therefore cannot believe that they are being subdued by a weapon.

The public might instinctively feel that something is wrong, but because of the technical nature of the silent weapon they cannot express their feeling in a rational way, or handle the problem with intelligence. Therefore, they do not know how to cry for help, and do not know how to associate with others to defend themselves against it.

When a silent weapon is applied gradually, the public adjusts / adapts to its presence and learns to tolerate its encroachment on their lives.

Therefore, the silent weapon is a type of biological warfare. It attacks the vitality, options, and mobility of the individuals of society by knowing, understanding, manipulating, and attacking their resources of natural and social energy, and their physical and mental, and emotional strengths and weaknesses.

In **preparation of the area targeted for the application of the Silent Weapon** is a program of studying the **communities habit patterns** is undertaken under a list of **Inputs** (surveillance) and **Outputs** (tailored on the findings of the surveillance) which covers *inter alia* the following headings: -

3 ²¹Intercepted in 1979 by **The Agency For Joint Intelligence Newsletters**. William Cooper (Ex USA Navy Intelligence), Camp Verde, Arizona, 86322, USA, Tel (602) 567-636,00 / 00 / 00, Daily Update (602) 1-900-535-9800 ext 240, Computer BBS (602) 567-6725, Hotline (213) 281-8222,000000, Orders (602) 567 6109 Research Center (602) 567 6536.

Inputs

General Sources of information

1. *telephone taps*
2. *surveillance*
3. *analysis of garbage*
4. *behaviour of children*

Standard of living by:

1. *Food*
2. *Clothing*
3. *Shelter*
4. *Transportation*

Social Contacts

1. *Telephone - itemised record of calls*
2. *family - marriage certificates, birth certificates etc.*
3. *friends, associates, etc.*
4. *membership in organisations*
5. *political affiliation*

THE PERSONAL PAPER TRAIL

Personal buying habits, i.e., personal consumer preferences

1. *Checking accounts*
2. *Credit Credit-card purchases*
3. *"tagged" credit card purchases - the credit purchase of products bearing the UPC (universal product Code)*

Assets:

1. *Checking accounts*
2. *savings accounts*
3. *real estate*
4. *business*
5. *automobile etc.*
6. *safety deposit at bank*
7. *stock market*

Liabilities

1. *creditors*
2. *enemies (see-legal)*
3. *loans*
4. *consumer credit*

*Government sources (ploys)**

1. *welfare*
2. *social security*
3. *surplus food*
4. *doles*
5. *grants*
6. *subsidies*

** Principal of this ploy - the citizen will almost always make the collection of information easy if he can operate on the principal of the "free sandwich principal" of "eat now, and pay later"*

Government sources (via intimidation)

1. *Internal revenue service*
2. *OSHA*
3. *Census*

4. *etc.*

Other government sources - surveillance of US mail.

Habit Patterns - Programming

Strengths and weaknesses,

1. *activities (sports, hobbies etc.)*
2. *see "legal" (fear anger, etc. - crime record)*
3. *hospital records (drug sensitivities, reaction to pain, etc.)*
4. *psychiatric records (fears, angers, disgusts, adaptability, reactions to stimuli, violence, suggestibility or hypnosis, pain, pleasure, love and sex)*

Methods of Coping - of adaptability - behaviour

1. *consumption of alcohol*
2. *consumption of drugs*
3. *entertainment religious factors influencing behaviour*
4. *other methods of escaping from reality*

Payment modus operandi,

1. *payment of telephone bills*
2. *energy purchases (electricity, gas etc.)*
3. *water purchases*
4. *repayment of loans*
5. *house payments*
6. *automobile payments*
7. *payments on credit cards*

Political sensitivity

1. *beliefs*
2. *contacts*
3. *position*
4. *strengths/weaknesses*
5. *projects/activities*

Legal inputs - behavioural control (excuses for investigation, search, arrest, or employment of force to modify behaviour)

1. *court records*
2. *police records - NCIC*
3. *driving record*
4. *reports made to police*
5. *insurance information*
6. *antiestablishment acquaintances*

NATIONAL INPUT INFORMATION

Business sources (via I.R.S., etc...)

1. *prices of commodities*
2. *sales*
3. *investments in*
 - a. *stocks / inventory*
 - b. *production tools and machinery*
 - c. *buildings and improvements*
 - d. *the stock markets*

Banks and credit bureaus

1. *credit information*
2. *payment information*

Miscellaneous sources:

3. *polls and surveys*
4. *publications*
5. *telephone records*
6. *energy and utility purchases*

SHORT LIST OF OUTPUTS

Outputs - create controlled situations - manipulation of economy, hence society - control by control of compensation and income

Sequence:

7. *allocates opportunities*
8. *destroys opportunities*
9. *controls the economic environment*
10. *controls the availability of raw materials*
11. *controls capital*
12. *controls bank rates*
13. *controls the inflation rate*
14. *controls the possession of property*
15. *controls industrial capacity*
16. *controls manufacturing*
17. *controls the availability of goods*
18. *controls the prices of commodities*
19. *controls services, the labour force, etc...*
20. *controls payments to government officials*
21. *controls the legal functions*
22. *controls the personal data files - uncorrectable by the party slandered.*
23. *controls advertising*
24. *controls media contact*
25. *controls material available for TV viewing*
26. *disengages attention from real issues*
27. *engages emotions*
28. *creates disorder, chaos, and insanity*
29. *controls design of more probing tax forms*
30. *controls surveillance*
31. *controls the storage of information*
32. *develops psychological analysis and profiles of individuals*
33. *controls legal functions (repeat of 15)*
34. *controls sociological factors*
35. *controls health options*
36. *preys on weaknesses*
37. *cripples strengths*
38. **leaches wealth and substance**

TABLE OF STRATEGIES

Do this

Keep the public ignorant
Maintain access control to point of feedback
Create preoccupation
Attach the family unit
Give less cash and more credit and doles
Attack the privacy of the church
Social conformity
Minimise the tax protest
problems
stabilise the consent

To get this

Less public organisation
Require reaction to outputs (prices sales)

Lower defenses
Control of the education of the young
More self-indulgence and more data
Destroy faith in this sort of government
Computer programming simplicity
Maximum economic data, minimum enforcement

Minimum coefficients

Tighten control of variables

Simpler computer input data - greater

predictability

Establish boundary conditions

Problem simplicity / solutions of differential and

different equations

Proper timing

less data shift and blurring

Maximise control

minimum resistance to control

Collapse of currency

destroy the faith of people in each other

The techniques employed vary from case to case but follow a basic sociological / psychological approach, perhaps best described by the following: -

DIVERSION THE PRIMARY STRATEGY

Experience has proven that the SIMPLEST METHOD of securing a silent weapon and gaining control of the public is to KEEP THE PUBLIC UNDISCIPLINED AND IGNORANT of the basic systems principals on the one hand, WHILE KEEPING THEM CONFUSED, DISORGANISED, AND DISTRACTED, with matters of no real importance on the other hand.

This is achieved by

39. disengaging their minds; sabotaging their mental activities; providing a low-quality program of public education in mathematics, logic, systems design and economics; and discouraging technical creativity.

40. Engaging their emotions, increasing their self-indulgence and their indulgence in emotional and physical activities, by:

a. unrelenting emotional affrontations and attacks (mental and emotional rape) by way of a constant barrage of sex, violence, and wars in the media - especially the TV and newspapers.

b. giving them what they desire - in excess - "junk food for thought" - and depriving them of what they really need

c. REWRITING HISTORY and LAW and SUBJECTING THE PUBLIC TO THE DEVIANT CREATION, thus being able to SHIFT THEIR THINKING from personal needs to highly fabricated outside priorities

*These preclude their interest in and discovery of the **SILENT WEAPONS OF SOCIAL AUTOMATION.***

The general rule is that there is profit in confusion, the more confusion the more profit. Therefore, the best approach is to create problems and then offer the solutions.

The Harvard Economic Research Project of 1948 forms the basis of the Economic Model employed in the manual, which divides people into three Industrial Classes i.e.:

1. Capital (resources)

2. Goods (commodities or use - dissipate)

3. Services (action of population)

a. nature sources of energy and raw materials

b. Government - printing of currency equal to gross national product

Extensive Industrial Diagrams accompany the manual, all of which cannot be included in this report.

As to the detailed approach used in training (brainwashing) seminars, the following should suffice to describe the basic approach model employed. One again this varies from case to case: -

Mind Control Apotheosis

The USA expository newsletter Mainstream²² provided extracts from a 200-page document entitled *Apotheosis Top Secret* which exposed how government officials were able to set about shifts in belief patterns in society. Here is a brief outline of the approach to be used: -

- A. Work slowly and gently. Establish common ground between subject and brain washer affirming present beliefs to generate an atmosphere of trust and fellowship*
- B. Isolate the subject from anything that reinforces his present beliefs, while at the same time immersing the subject in the new belief environment. Allow no time for thought or reflection - this can be done by constant companionship between subject and brain washer*
- C. Generate a deeper emotional alliance between subject and brain washers. Develop belonging and companionship.*
- D. Increase emotional alliance while presenting new beliefs in ways that do not directly trigger contrast or argument.*
- E. Begin to dismantle the old beliefs by playful mockery and introduce camouflaged version of new beliefs.*
- F. Suggest the old belief is no longer valid or useful, and is subservient to the new belief which has now superseded it, while immersing subject in a sense of just cause.*
- G. Remove subjects last connections and habits relating to the old belief using sleep deprivation, changes in diet, new life patterns and emotional dependency.*
- H. When subject repeatedly shows allegiance to new belief, begin direct teaching - do not mention the old belief or refer to it.*
- I. When subject shows understanding and acceptance of the naked, undisguised new belief, challenge the old belief and overthrow it.*
- J. The brainwashing process is now complete, and the subject will now filter experiences in a manner that reinforces the new belief. Thus, it becomes a self-perpetuating process.*

What is of course not mentioned in the above is that those who refuse to fall for this then become isolated in the community that has been successfully brainwashed and their children who are forced to interact with the community through schooling are then brainwashed through relentless school activities and turned against the parents. Then next generation is then secured even if all of the present cannot.

4 ²²Mainstream Newsletter Address P O Box 1850, Kempton Park, 1620 (South African office) published by P Tillen o Banner ministries UK

Notices of Commission

THE COMMISSION OF INQUIRY INTO ADMINISTRATIVE IRREGULARITIES IN THE JUDICIAL SYSTEM AND ACTIVITIES BY MEMBERS OF SECRET SOCIETIES

- a. This Commission was condoned by **His Lordship Justice Mall** of the **Durban and Coast Local Division of the Supreme Court of South Africa (Now on the Truth and Reconciliation Commission)** on the **24th day of May 1995** as per **pages 11 at 20-30, 12 at 5 and 14 of the transcript of case No A 175/93**.
- b. The Commission manifests as an **Actio Popularis** Commission.
- c. It operates under **Sections 8(1) 9, 15, 18, 32, 33, 34, 38, 198, 231 (5), 232, 233, and Schedule 6 (22) of Constitution of the Republic of South Africa** and as such is **independent of any organ of state**.
- d. Its Terms of Reference covers *inter alia* **any other related matters** into the topic of its description.
- e. This Commission does not fall under the Commission's Statute, and is therefore appropriately able to **independently** and *without encumbrances* to **investigate organs of state** in line with the official state doctrine of **Openness and Transparency**. _
- f. None of its investigating officers are Officers of Court in order that it may similarly appropriately **investigate the activities of Officers of Court** (i.e., attorneys, Advocates, Public Prosecutors, Magistrates and Judges).
- g. This Commission has, at this stage, no *quasi-judicial* powers of itself, but **it may provide evidence** to any other personam, instance or agency, in any litigation before the Courts or any other recognised forum, or to bodies fulfilling similar roles such as the **Truth and Reconciliation Commission**.
- h. This Commission or any of its members, agents and employees **may litigate** in personam, or under **section 38** of the Constitution, or on any other legal grounds as are disposable to any person at law **in any tribunal or forum** as provided for under **Section 34** of the Constitution of the Republic of South Africa, having regard to such international instruments as the **Helsinki Accord** in line with the provisions encapsulated in **sections 321, 232 and 39 of the Constitution**.
- i. This Commission has found it necessary (due to a host of death threats against its investigating officers) that the findings of this Commission be published on the **Internet** from time to time in order to secure the safety of the investigating officers. Access to the web site concerned is secured under the auspices of **International Agencies** engaged in similar investigations and are therefore not as yet accessible to the public at large.
- j. Members of the public are invited to supply any information that may assist this Commission in its investigations.
- k. This commission is **assisted by local and International Agencies** involved in similar work.
- l. This Commission is **not state funded** but **independently funded from the populous at large**.

CHAPTER SEVEN

Summary

Freemasonry is a subtle system whereby the initiate is first told that he has nothing to fear in respect of his present beliefs because Freemasonry is not a religion. The Mason is then taught that Freemasonry as a fraternity is truly interfaith in nature and that all roads lead to the “grand Architect of the universe”

The only personal God Freemasonry admits to is humanity – a system of deified secular Humanism.

Masonry then exposes its members to a long, complex and highly secretive series of rituals. All of these are all based on what they refer to as the “Ancient Mysteries” which it eventually exposes as being Cabalism in its finest degree. This pursuit of Cabalistic lore eventually illuminates the Mason to the truth, i.e., that Lucifer is the equal to Christ but the better of the two Gods as he is the light bearer. This Luciferic Illumination is then what enables the Mason to grasp the real purpose of those who can be entrusted with running the world and only then can he play a part in this task.

What to do if I am a Christian?

Hosea 4:6 – My people are destroyed for lack of knowledge: Because though hast rejected knowledge, I will also reject thee, that thou shalt be no priest to me: seeing thou hast forgotten the law of thy God, I will also forget thy children.

Proverbs 9:10 – The fear of God is the beginning of Wisdom: and the knowledge of the Holy is understanding.

Luke 24:45 – Then opened he their understanding that they might understand the scriptures.

Acts 19:18 And many that believed came, and confessed, and shewed their deeds.

Acts 19:19 Many of them also which used curious arts brought their books together, and burned them before all [men]: and they counted the price of them, and found [it] fifty thousand [pieces] of silver.

*II Corinthians 6:14 Be ye not unequally yoked together with unbelievers: for what fellowship hath righteousness with unrighteousness? and **what communion hath light with darkness?***

*II Corinthians 6:15 And **what concord hath Christ with Belial?** or what part hath he that believeth with an infidel?*

II Corinthians 6:16 And what agreement hath the temple of God with idols? for ye are the temple of the living God; as God hath said, I will dwell in them, and walk in [them]; and I will be their God, and they shall be my people.

*II Corinthians 6:17 Wherefore **come out from among them, and be ye separate, saith the Lord, and touch not the unclean [thing]; and I will receive you,***

II Corinthians 6:18 And will be a Father unto you, and ye shall be my sons and daughters, saith the Lord Almighty.

Way of Salvation in the Bible

*John 3:3 Jesus answered and said unto him, Verily, verily, I say unto thee, **except a man be born again, he cannot see the kingdom of God.***

John 3:7 Marvel not that I said unto thee, Ye must be born again.

I Peter 1:23 Being born again, not of corruptible seed, but of incorruptible, by the word of God, which liveth and abideth forever.

*Acts 8:12 But **when they believed** Philip preaching the things concerning the kingdom of God, and the name of Jesus Christ, **they were baptized**, both men and women.*

*Acts 8:13 Then **Simon himself believed** also: and when he **was baptized**, he continued with Philip, and wondered, beholding the miracles and signs which were done.*

*Acts 18:8 And Crispus, the chief ruler of the synagogue, **believed on the Lord** with all his house; and many of the Corinthian's hearing believed, and were baptized.*

Mark 16:15 And he said unto them, go ye into all the world, and preach the gospel to every creature.

*Mark 16:16 **He that believeth and is baptized shall be saved**; but he that believeth not shall be damned.*

*Matthew 3:16 And Jesus, when he was baptized, went **up** straightway **out of the water**: and, lo, the heavens were opened unto him, and he saw the **Spirit of God** descending like a dove, and lighting upon him:*

*Ephesians 1:13 In whom ye also [trusted], after that ye heard the word of truth, the gospel of your salvation: in whom also after that ye believed, ye were **sealed with that holy Spirit of promise**,*

Ephesians 4:30 And grieve not the holy Spirit of God, whereby ye are sealed unto the day of redemption.

*Matthew 7:21 **Not everyone that saith unto me, Lord, Lord, shall enter into the kingdom of heaven; but he that doeth the will of my Father which is in heaven.***

Matthew 7:22 Many will say to me in that day, Lord, Lord, have we not prophesied in thy name? and in thy name have cast out devils? and in thy name done many wonderful works?

*Matthew 7:23 And then will I profess unto them, I never knew you: depart from me, **ye that work iniquity.***

*II Timothy 4:2 **Preach the word; be instant in season, out of season; reprove, rebuke, exhort with all longsuffering and doctrine.***

II Timothy 4:3 For the time will come when they will not endure sound doctrine; but after their own lusts shall they heap to themselves teachers, having itching ears;

*II Timothy 4:4 And they shall turn away [their] ears from the truth, and **shall be turned unto fables.***

*II Timothy 4:5 But watch thou in all things, **endure afflictions, do the work of an evangelist, make full proof of thy ministry.***

*Ephesians 4:14 That we [henceforth] **be no more children, tossed to and fro, and carried about with every wind of doctrine, by the sleight of men, [and] cunning craftiness, whereby they lie in wait to deceive;***

*James 1:8 **A double minded man [is] unstable in all his ways.***

*Proverbs 22:3 A **prudent [man] foreseeth the evil, and hideth himself: but the simple pass on, and are punished.***

*I John 5:12 **He that hath the Son hath life; [and] he that hath not the Son of God hath not life.***

*I Timothy 2:5 **For [there is] one God, and one mediator between God and men, the man Christ Jesus;***

Covenant Oath of God and of man

*Matthew 26:28 For this is my **blood of the New Testament**, which is shed for many **for the remission of sins.***

*Luke 22:20 Likewise also the cup after supper, saying, this cup [is] the New Testament in my **blood, which is shed for you.***

*Matthew 20:28 Even as the Son of man came not to be ministered unto, but to minister, and to **give his life a ransom for many.***

James 1:8 A double minded man [is] unstable in all his ways.

Proverbs 22:3 A prudent [man] foreseeth the evil, and hideth himself: but the simple pass on, and are punished.

The armour of God

Ephesians 6:11 Put on the whole armour of God, that ye may be able to stand against the wiles of the devil.

Ephesians 6:12 For we wrestle not against flesh and blood, but against principalities, against powers, against the rulers of the darkness of this world, against spiritual wickedness in high [places].

Ephesians 6:13 Wherefore take unto you the whole armour of God, that ye may be able to withstand in the evil day, and having done all, to stand.

*Ephesians 6:14 Stand therefore, having your loins girt about with **truth**, and having on the **breastplate of righteousness**;*

*Ephesians 6:15 And your **feet shod** with the preparation of the **gospel of peace**;*

*Ephesians 6:16 Above all, taking the **shield of faith**, wherewith ye shall be able to quench all the fiery darts of the wicked.*

*Ephesians 6:17 And take the **helmet of salvation**, and the sword of the Spirit, which is the word of God:*

*Ephesians 6:18 **Praying** always with all prayer and supplication **in the Spirit**, and watching thereunto with all perseverance and supplication for all saints;*

I Corinthians 9:27 But I keep under my body, and bring [it] into subjection: lest that by any means, when I have preached to others, I myself should be a castaway.

Other points to consider are: -

- ✓ Ritual of water baptism death, restitution and resurrection
- ✓ Enlightenment by Holy Spirit
- ✓ Witnesses of 1John 5:7
- ✓ The mandate of God and his deal
- ✓ Acceptance of Christ
- ✓ Asking of forgiveness
- ✓ Repentance - Prayer of renunciation.
- ✓ Go and Preach the Gospel of the Kingdom of Christ.
- ✓ Entrance into Fellowship of Saints

- ✓ Allocation of Eldership.
- ✓ Setting up lines of communication.
- ✓ The law of God and Prophecy

GODS PLAN OF SALVATION

The Bible says there is only one way to Heaven

Jesus said: *"I am the way, the truth, and the life: no man cometh unto the Father but by me."* **(John 14:6)**

Good works cannot save you.

"For by grace are ye saved through faith; and that not of yourselves: it is the gift of God: Not of works, lest any man should boast." **(Ephesians 2:8-9)**

Trust Jesus Christ today! Here's what you must do:

1. Admit you are a sinner.

"For all have sinned, and come short of the glory of God;" **(Romans 3:23)**

"Wherefore, as by one man sin entered into the world, and death by sin; and so, death passed upon all men, for that all have sinned:" **(Romans 5:12)**

"If we say that we have not sinned, we make him a liar, and his word is not in us."
(1 John 1:10)

2. Be willing to turn from sin (repent).

Jesus said: *"I tell you, Nay: but, except ye repent, ye shall all likewise perish."*
(Luke 13:5)

"And the times of this ignorance God winked at; but now commandeth all men everywhere to repent:" **(Acts 17:30)**

3. Believe that Jesus Christ died for you, was buried, and rose from the dead.

"For God so loved the world, that he gave his only begotten Son, that whosoever believeth in him should not perish, but have everlasting life." **(John 3:16)**

"But God commendeth his love toward us, in that, while we were yet sinners. Christ died for us." **(Romans 5:8)**

"That if thou shalt confess with thy mouth the Lord Jesus, and shalt believe in thine heart that God hath raised him from the dead, thou shalt be saved."

(Romans 10:9)

4. Through prayer, invite Jesus into your life to become your personal Saviour.

"For with the heart man believeth unto righteousness; and with the mouth confession is made unto salvation." (Romans 10:10)

"For whosoever shall call upon the name of the Lord shall be saved."

(Romans 10:13)

What to pray:

Dear God, I am a sinner and need forgiveness. I believe that Jesus Christ shed His **precious blood** and died for my sin. I am willing to turn from sin. I now invite Christ to come into my heart and life as my personal Saviour.

"But as many as received him, to them gave the power to become the sons of God, even to them that believe on his name:" (John 1:12)

"Therefore, if any man be in Christ, he is a new creature: old things are passed away; behold, all things are become new." (2 Corinthians 5:17)

If you have received Jesus Christ as your Saviour, as a Christian you should:

1. Read your Bible every day to get to know Christ better.

"Study to shew thyself approved unto God, a workman that needeth not to be ashamed, rightly dividing the word of truth." (2 Timothy 2:15)

"Thy word is a lamp unto my feet, and a light unto my path." (Psalms 119:105)

2. Talk to God in prayer every day.

"And all things, whatsoever ye shall ask in prayer, believing, ye shall receive."

(Matthew 21:22)

"Be careful for nothing; but in everything by prayer and supplication with thanksgiving let your requests be made known unto God." (Philippians 4:6)

3. Be baptized, worship, fellowship, and serve with other Christians in a church where Christ is preached and the Bible is the final authority.

"Go ye therefore, and teach all nations, baptizing them in the name of the Father, and of the Son, and of the Holy Ghost:" (Matthew 28:19)

"Not forsaking the assembling of ourselves together, as the manner of some is; but exhorting one another: and so much the more, as ye see the day approaching." (Hebrews 10:25)

"All scripture is given by inspiration of God, and is profitable for doctrine, for reproof, for correction, for instruction in righteousness:" (2 Timothy 3:16)

4. Tell others about Christ.

"And he said unto them, go ye into all the world, and preach the gospel to every creature." (Mark 16:15)

"For though I preach the gospel, I have nothing to glory of: for necessity is laid upon me; yea, woe is unto me, if I preach not the gospel!" (1 Corinthians 9:16)

"For I am not ashamed of the gospel of Christ: for it is the power of God unto salvation to everyone that believeth; to the Jew first, and also to the Greek." (Romans 1:16)



MORE SCRIPTURES FOR FREEMASONS

PRINCIPALITIES AND POWERS

Ephesians 6:11 Put on the whole armour of God, that ye may be able to stand against the wiles of the devil.

Ephesians 6:12 For we wrestle not against flesh and blood, but against principalities, against powers, against the rulers of the darkness of this world, against spiritual wickedness in high [places].

I Timothy 2:1 I exhort therefore, that, first of all, supplications, prayers, intercessions, [and] giving of thanks, be made for all men;

OATHS

Matthew 5:37 But let your communication be, Yea, yea; Nay, nay: for whatsoever is more than these cometh of evil.

Matthew 5:34 But I say unto you, swear not at all; neither by heaven; for it is God's throne:

James 5:12 But above all things, my brethren, swear not, neither by heaven, neither by the earth, neither by any other oath: but let your yea be yea; and [your] nay, nay; lest ye fall into condemnation.

SECRECY

Matthew 24:26 Wherefore if they shall say unto you, Behold, he is in the desert; go not forth: behold, [he is] in the secret chambers; believe [it] not.

Mark 4:22 For there is nothing hid, which shall not be manifested; neither was anything kept secret, but that it should come abroad.

Luke 8:17 For nothing is secret, that shall not be made manifest; neither [anything] hid, that shall not be known and come abroad.

Luke 11:33 No man, when he hath lighted a candle, putteth [it] in a secret place, neither under a bushel, but on a candlestick, that they which come in may see the light.

John 7:4 For [there is] no man [that] doeth anything in secret, and he himself seeketh to be known openly. If thou do these things, shew thyself to the world.

John 18:20 Jesus answered him, I spake openly to the world; I ever taught in the synagogue, and in the temple, whither the Jews always resort; and in secret have I said nothing.

Ephesians 5:12 For it is a shame even to speak of those things which are done of them in secret.

Isaiah 29:15 Woe unto them that seek deep to hide their counsel from the LORD, and their works are in the dark, and they say, Who seeth us? and who knoweth us?

Genesis 49:6 O my soul, come not thou into their secret; unto their assembly, mine honour, be not thou united: for in their anger, they slew a man, and in their self-will they digged down a wall.

Psalms 25:14 The secret of the LORD [is] with them that fear him; and he will shew them his covenant.

LIGHT

John 8:12 Then spake Jesus again unto them, saying, I am the light of the world: he that followeth me shall not walk in darkness, but shall have the light of life.

Ephesians 5:14 Wherefore he saith, awake thou that sleepest, and arise from the dead, and Christ shall give thee light.

II Corinthians 11:14 And no marvel; for Satan himself is transformed into an angel of light.

II Corinthians 4:6 For God, who commanded the light to shine out of darkness, hath shined in our hearts, to [give] the light of the knowledge of the glory of God in the face of Jesus Christ.

Acts 26:18 To open their eyes, [and] to turn [them] from darkness to light, and [from] the power of Satan unto God, that they may receive forgiveness of sins, and inheritance among them which are sanctified by faith that is in me.

Proverbs 4:19 The way of the wicked [is] as darkness: they know not at what they stumble.

Matthew 6:22 The light of the body is the eye: if therefore thine eye be single, thy whole body shall be full of light.

Matthew 6:23 But if thine eye be evil, thy whole body shall be full of darkness. If therefore the light that is in thee be darkness, how great [is] that darkness!

Ephesians 4:18 Having the understanding darkened, being alienated from the life of God through the ignorance that is in them, because of the blindness of their heart:

GODS NAME

Romans 8:15 For ye have not received the spirit of bondage again to fear; but ye have received the Spirit of adoption, whereby we cry, Abba, Father.

See book on Yahweh

HIRAM ABIF KING OF TYRE (ITHOBALUS 11)

Ezekiel 28:12 Son of man, take up a lamentation upon the king of Tyrus, and say unto him, thus saith the Lord GOD; Thou sealest up the sum, full of wisdom, and perfect in beauty.

Ezekiel 28:13 Thou hast been in Eden the garden of God; every precious stone [was] thy covering, the sardius, topaz, and the diamond, the beryl, the onyx, and the jasper, the sapphire, the emerald, and the carbuncle, and gold: the workmanship of thy tabrets and of thy pipes was prepared in thee in the day that thou wast created.

Ezekiel 28:14 Thou [art] the anointed cherub that covereth; and I have set thee [so]: thou wast upon the holy mountain of God; thou hast walked up and down in the midst of the stones of fire.

Ezekiel 28:15 Thou [wast] perfect in thy ways from the day that thou wast created, till iniquity was found in thee.

Ezekiel 28:16 By the multitude of thy merchandise they have filled the midst of thee with violence, and thou hast sinned: therefore, I will cast thee as profane out of the mountain of God: and I will destroy thee, O covering cherub, from the midst of the stones of fire.

Ezekiel 28:17 Thine heart was lifted up because of thy beauty, thou hast corrupted thy wisdom by reason of thy brightness: I will cast thee to the ground, I will lay thee before kings, that they may behold thee.

Ezekiel 28:18 Thou hast defiled thy sanctuaries by the multitude of thine iniquities, by the iniquity of thy traffic; therefore will I bring forth a fire from the midst of thee, it shall devour thee, and I will bring thee to ashes upon the earth in the sight of all them that behold thee.

Ezekiel 28:19 All they that know thee among the people shall be astonished at thee: thou shalt be a terror, and never [shalt] thou [be] any more.

Isaiah 23:1 The burden of Tyre. Howl, ye ships of Tarshish; for it is laid waste, so that there is no house, no entering in: from the land of Chittim, it is revealed to them.

Isaiah 23:5 As at the report concerning Egypt, [so] shall they be sorely pained at the report of Tyre.

Isaiah 23:8 Who hath taken this counsel against Tyre, the crowning [city], whose merchants [are] princes, whose traffickers [are] the honourable of the earth?

Isaiah 23:15 And it shall come to pass in that day, that Tyre shall be forgotten seventy years, according to the days of one king: after the end of seventy years shall Tyre sing as a harlot.

Isaiah 23:17 And it shall come to pass after the end of seventy years, that the LORD will visit Tyre, and she shall turn to her hire, and shall commit fornication with all the kingdoms of the world upon the face of the earth.

Joel 3:4 Yea, and what have ye to do with me, O Tyre, and Zidon, and all the coasts of Palestine? will ye render me a recompence? and if ye recompence me, swiftly [and] speedily will I return your recompence upon your own head;

Matthew 11:21 Woe unto thee, Chorazin! woe unto thee, Bethsaida! for if the mighty works, which were done in you, had been done in Tyre and Sidon, they would have repented long ago in sackcloth and ashes.

Matthew 11:22 But I say unto you, it shall be more tolerable for Tyre and Sidon at the day of judgment, than for you.

I Kings 5:1 And Hiram king of Tyre sent his servants unto Solomon; for he had heard that they had anointed him king in the room of his father: for Hiram was ever a lover of David.

I Kings 5:11 And Solomon gave Hiram twenty thousand measures of

wheat [for] food to his household, and twenty measures of pure oil: thus gave Solomon to Hiram year by year.

I Kings 5:12 And the LORD gave Solomon wisdom, as he promised him: and there was peace between Hiram and Solomon; and they two made a league together.

I Kings 9:12 And Hiram came out from Tyre to see the cities which Solomon had given him; and they pleased him not.

I Kings 9:27 And Hiram sent in the navy his servants, shipmen that had knowledge of the sea, with the servants of Solomon.

I Kings 10:11 And the navy also of Hiram, that brought gold from Ophir, brought in from Ophir great plenty of almug trees, and precious stones.

I Kings 10:22 For the king had at sea a navy of Tarshish with the navy of Hiram: once in three years came the navy of Tarshish, bringing gold, and silver, ivory, and apes, and peacocks.

I Chronicles 14:1 Now Hiram king of Tyre sent messengers to David, and timber of cedars, with masons and carpenters, to build him an house.

BOAZ

Ruth 4:13 So Boaz took Ruth, and she was his wife: and when he went in unto her, the LORD gave her conception, and she bare a son.

II Chronicles 3:17 And he reared up the pillars before the temple, one on the right hand, and the other on the left; and called the name of that on the right-hand Jachin, and the name of that on the left Boaz.

II Chronicles 3:17 And he reared up the pillars before the temple, one on the right hand, and the other on the left; and called the name of that on the right-hand Jachin, and the name of that on the left Boaz.

KINSMAN'S REDEMPTION BOAZ

RUTH 3 - 4 Deals at length with the 'Kinsman's Redemption' practiced in Boaz's time. This had particularly to do, also, with inheritance: -

Ruth 3:9 And he said, Who [art] thou? And she answered, I [am]

Ruth thine handmaid: spread therefore thy skirt over thine handmaid; for thou [art] a near kinsman.

Ruth 3:10 And he said, Blessed [be] thou of the LORD, my daughter: [for] thou hast shewed more kindness in the latter end than at the beginning, inasmuch as thou followedst not young men, whether poor or rich.

Ruth 3:11 And now, my daughter, fear not; I will do to thee all that thou requirest: for all the city of my people doth know that thou [art] a virtuous woman.

Ruth 3:12 And now it is true that I [am thy] near kinsman: howbeit there is a kinsman nearer than I.

Ruth 3:13 Tarry this night, and it shall be in the morning, [that] if he will perform unto thee the part of a kinsman, well; let him do the kinsman's part: but if he will not do the part of a kinsman to thee, then will I do the part of a kinsman to thee, [as] the LORD liveth: lie down until the morning.

Ruth 3:14 And she lay at his feet until the morning: and she rose up before one could know another. And he said, let it not be known that a woman came into the floor.

Ruth 4:1 Then went Boaz up to the gate, and sat him down there: and, behold, the kinsman of whom Boaz spake came by; unto whom he said, Ho, such a one! turn aside, sit down here. And he turned aside, and sat down.

Ruth 4:2 And he took ten men of the elders of the city, and said, Sit ye down here. And they sat down.

Ruth 4:3 And he said unto the kinsman, Naomi, that is come again out of the country of Moab, selleth a parcel of land, which [was] our brother Elimelech's:

Ruth 4:4 And I thought to advertise thee, saying, Buy [it] before the inhabitants, and before the elders of my people. If thou wilt redeem [it], redeem [it]: but if thou wilt not redeem [it, then] tell me, that I may know: for [there is] none to redeem [it] beside thee; and I [am] after thee. And he said, I will redeem [it].

Ruth 4:5 Then said Boaz, What day thou buyest the field of the hand of Naomi, thou must buy [it] also of Ruth the Moabitess, the wife of the dead, to raise up the name of the dead upon his inheritance.

Ruth 4:6 And the kinsman said, I cannot redeem [it] for myself, lest I mar mine own inheritance: redeem thou my right to thyself; for I cannot redeem [it].

Ruth 4:7 Now this [was the manner] in former time in Israel concerning redeeming and concerning changing, for to confirm all things; a man plucked off his shoe, and gave [it] to his neighbour: and this [was] a testimony in Israel.

Ruth 4:8 Therefore the kinsman said unto Boaz, Buy [it] for thee. So, he drew off his shoe.

Ruth 4:9 And Boaz said unto the elders, and [unto] all the people, Ye [are] witnesses this day, that I have bought all that [was] Elimelech's, and all that [was] Chilion's and Mahlon's, of the hand of Naomi.

Ruth 4:10 Moreover Ruth the Moabitess, the wife of Mahlon, have I purchased to be my wife, to raise up the name of the dead upon his inheritance, that the name of the dead be not cut off from among his brethren, and from the gate of his place: ye [are] witnesses this day.

Ruth 4:13 So Boaz took Ruth, and she was his wife: and when he went in unto her, the LORD gave her conception, and she bare a son.

Ruth 4:14 And the women said unto Naomi, Blessed [be] the LORD, which hath not left thee this day without a kinsman, that his name may be famous in Israel.

Ruth 4:17 And the women her neighbours gave it a name, saying, there is a son born to Naomi; and they called his name Obed: he [is] the father of Jesse, the father of David.

Ruth 4:18 Now these [are] the generations of Pharez: Pharez begat Hezron,

Ruth 4:19 And Hezron begat Ram, and Ram begat Amminadab,

Ruth 4:20 And Amminadab begat Nahshon, and Nahshon begat Salmon,

Ruth 4:21 And Salmon begat Boaz, and Boaz begat Obed,

Ruth 4:22 And Obed begat Jesse, and Jesse begat David.

Matthew 1:5 And Salmon begat Booz of Rachab; and Booz begat Obed of Ruth; and Obed begat Jesse;

Luke 3:32 Which was [the son] of Jesse, which was [the son] of Obed, which was [the son] of Booz, which was [the son] of Salmon, which was [the son] of Naasson,

CORNER STONE

Question by Pharisees

Mark 11:27 And they come again to Jerusalem: and as he was walking in the temple, there come to him the chief priests, and the scribes, and the elders,

Mark 11:28 And say unto him, By what authority doest thou these things? and who gave thee this authority to do these things?

Mark 11:29 And Jesus answered and said unto them, I will also ask of you one question, and answer me, and I will tell you by what authority I do these things.

Mark 11:30 The baptism of John, was [it] from heaven, or of men? answer me.

Mark 11:31 And they reasoned with themselves, saying, If we shall say, From heaven; he will say, Why then did ye not believe him?

Mark 11:32 But if we shall say, Of men; they feared the people: for all [men] counted John, that he was a prophet indeed.

Mark 11:33 And they answered and said unto Jesus, We cannot tell. And Jesus answering saith unto them, Neither do I tell you by what authority I do these things.

Parable of Vineyard

Mark 12:1 And he began to speak unto them by parables. A [certain] man planted a vineyard, and set a hedge about [it], and digged [a place for] the wine fat, and built a tower, and let it out to husbandmen, and went into a far country.

Mark 12:2 And at the season he sent to the husbandmen a servant, that he might receive from the husbandmen of the fruit of the vineyard.

Mark 12:3 And they caught [him], and beat him, and sent [him] away empty.

Mark 12:4 And again he sent unto them another servant; and at him they cast stones, and wounded [him] in the head, and sent [him] away shamefully handled.

Mark 12:5 And again he sent another; and him they killed, and many others; beating some, and killing some.

Mark 12:6 Having yet therefore one son, his well-beloved, he sent him also last unto them, saying, they will reverence my son.

Mark 12:7 But those husbandmen said among themselves, this is the heir; come, let us kill him, and the inheritance shall be ours.

Mark 12:8 And they took him, and killed [him], and cast [him] out of the vineyard.

Mark 12:9 What shall therefore the lord of the vineyard do? he will come and destroy the husbandmen, and will give the vineyard unto others.

Mark 12:10 And have ye not read this scripture; _The stone which the builders rejected is become the head of the corner: _

Mark 12:11 _This was the Lord's doing, and it is marvelous in our eyes? _

Mark 12:12 And they sought to lay hold on him, but feared the people: for they knew that he had spoken the parable against them: and they left him, and went their way.

Why? they were already in the mystery of iniquity the cabal etc. - He was quoting from David's Psalms...

Psalms 118:1 O give thanks unto the LORD; for [he is] good: because his mercy [endureth] forever.

Psalms 118:2 Let Israel now say, that his mercy [endureth] forever.

Psalms 118:3 Let the house of Aaron now say, that his mercy [endureth] forever.

Psalms 118:4 Let them know that fear the LORD say, that his mercy [endureth] forever.

Psalms 118:5 I called upon the LORD in distress: the LORD answered me, [and set me] in a large place.

Psalms 118:6 The LORD [is] on my side; I will not fear: what can man do unto me?

Psalms 118:7 The LORD taketh my part with them that help me: therefore, shall I see [my desire] upon them that hate me.

Psalms 118:8 [It is] better to trust in the LORD than to put confidence in man.

Psalms 118:9 [It is] better to trust in the LORD than to put confidence in princes.

Psalms 118:10 All nations compassed me about: but in the name of the LORD will I destroy them.

Psalms 118:11 They compassed me about; yea, they compassed me about: but in the name of the LORD, I will destroy them.

Psalms 118:12 They compassed me about like bees; they are quenched as the fire of thorns: for in the name of the LORD, I will destroy them.

Psalms 118:13 Thou hast thrust sore at me that I might fall: but the LORD helped me.

Psalms 118:14 The LORD [is] my strength and song, and is become my salvation.

Psalms 118:15 The voice of rejoicing and salvation [is] in the tabernacles of the righteous: the right hand of the LORD doeth valiantly.

Psalms 118:16 The right hand of the LORD is exalted: the right hand of the LORD doeth valiantly.

Psalms 118:17 I shall not die, but live, and declare the works of the LORD.

Psalms 118:18 The LORD hath chastened me sore: but he hath not given me over unto death.

Psalms 118:19 Open to me the gates of righteousness: I will go into them, [and] I will praise the LORD:

Psalms 118:20 This gate of the LORD, into which the righteous shall enter.

Psalms 118:21 I will praise thee: for thou hast heard me, and art become my salvation.

Psalms 118:22 _The stone [which] the builders refused is become the head [stone] of the corner. _

Psalms 118:23 _This is the LORD'S doing; it [is] marvelous in our eyes. _

Psalms 118:24 This [is] the day [which] the LORD hath made; we will rejoice and be glad in it.

Psalms 118:25 Save now, I beseech thee, O LORD: O LORD, I beseech thee, send now prosperity.

Psalms 118:26 Blessed [be] he that cometh in the name of the LORD: we have blessed you out of the house of the LORD.

Psalms 118:27 God [is] the LORD, which hath shewed us light: bind the sacrifice with cords, [even] unto the horns of the altar.

Psalms 118:28 Thou [art] my God, and I will praise thee: [thou art] my God, I will exalt thee.

Psalms 118:29 O give thanks unto the LORD; for [he is] good: for his mercy [endureth] forever.

String

Isaiah 8:14-19, 28:16 on, 49:7 Ps 118:22-23,

Math 21:42, Acts 4:11, 1Pet 2:4-8

Isaiah 28:7 But they also have erred through wine, and through strong drink are out of the way; the priest and the prophet have erred through strong drink, they are swallowed up of wine, they are out of the way through strong drink; they err in vision, they stumble [in] judgment.

Isaiah 28:14 Wherefore hear the word of the LORD, ye scornful men, that rule this people which [is] in Jerusalem.

Isaiah 28:15 Because ye have said, _We have made a covenant with death, and with hell are we at agreement_; when the overflowing scourge shall pass through, it shall not come unto us: for we have made lies our refuge, and _under falsehood have we hid ourselves: _

Isaiah 28:16 Therefore thus saith the Lord GOD, _Behold, I lay in Zion for a foundation a stone, a tried stone, a precious corner [stone], a sure foundation: he that believeth shall not make haste. _

Isaiah 28:17 _Judgment also will I lay to the line, and righteousness to the plummet_: and the hail shall sweep away the _refuge of lies, _ and the waters shall overflow the _hiding place_.

Isaiah 28:18 _And your covenant with death shall be disannulled, and your agreement with hell shall not stand; when the overflowing scourge shall pass through, then ye shall be trodden down by it. _

Isaiah 28:19 From the time that it goeth forth it shall take you: for morning by morning shall it pass over, by day and by night: and it shall be a vexation only [to] understand the report.

Isaiah 28:20 _For the bed is shorter than that [a man] can stretch himself [on it]: and the covering narrower than that he can wrap himself [in it]._

Isaiah 28:21 For the LORD shall rise up as [in] mount Perazim, he shall be wroth as [in] the valley of Gibeon, that he may do his work, his strange work; and bring to pass his act, his strange act.

Isaiah 28:22 Now therefore be ye not mockers, _lest your bands be made strong_: for I have heard from the Lord GOD of hosts a consumption, even determined upon the whole earth.

Isaiah 28:23 Give ye ear, and hear my voice; hearken, and hear my speech.

Isaiah 28:24 Doth the plowman plow all day to sow? doth he open and break the clods of his ground?

Isaiah 28:25 When he hath made plain the face thereof, doth he not cast abroad the fitches, and scatter the cummin, and cast in the principal wheat and the appointed barley and the rie in their place?

Isaiah 28:26 _For his God doth instruct him to discretion, [and] doth teach him._

Isaiah 28:29 _This also cometh forth from the LORD of hosts, [which] is wonderful in counsel, [and] excellent in working._

Isaiah 29:1 Woe to Ariel, to Ariel, the city [where] David dwelt! add ye year to year; let them kill sacrifices.

Ariel is Jerusalem

Isaiah 29:2 Yet I will distress Ariel, and there shall be heaviness and sorrow: and it shall be unto me as Ariel.

Isaiah 29:3 And I will camp against thee round about, and will lay siege against thee with a mount, and I will raise forts against thee.

Isaiah 29:4 And thou shalt be brought down, [and] shalt speak out of the ground, and thy speech shall be low out of the dust, and thy voice shall be, as of one that hath a familiar spirit, out of the ground, and thy speech shall whisper out of the dust.

Isaiah 29:5 Moreover the multitude of thy strangers shall be like small dust, and the multitude of the terrible ones [shall be] as chaff that passeth away: yea, it shall be at an instant suddenly.

Isaiah 29:6 Thou shalt be visited of the LORD of hosts with thunder, and with earthquake, and great noise, with storm and tempest, and the flame of devouring fire.

Isaiah 29:7 And the multitude of all the nations that fight against Ariel, even all that fight against her and her munition, and that distress her, shall be as a dream of a night vision.

Isaiah 29:8 It shall even be as when an hungry [man] dreameth, and, behold, he eateth; but he awaketh, and his soul is empty: or as when a thirsty man dreameth, and, behold, he drinketh; but he awaketh, and, behold, [he is] faint, and his soul hath appetite: so shall the multitude of all the nations be, that fight against mount Zion.

Isaiah 29:9 Stay yourselves, and wonder; cry ye out, and cry: they are drunken, but not with wine; they stagger, but not with strong drink.

Isaiah 29:10 For the LORD hath poured out upon you the spirit of deep sleep, and hath closed your eyes: the prophets and your rulers, the seers hath he covered.

Isaiah 29:11 And the vision of all is become unto you as the words of a book that is sealed, which [men] deliver to one that is learned, saying, Read this, I pray thee: and he saith, I cannot; for it [is] sealed:

Isaiah 29:12 And the book is delivered to him that is not learned, saying, Read this, I pray thee: and he saith, I am not learned.

Isaiah 29:13 Wherefore the Lord said, _Forasmuch as this people draw near [me] with their mouth, and with their lips do honour me, but have removed their heart far from me, and their fear toward me is taught by the precept of men: _

Isaiah 29:14 Therefore, behold, I will proceed to do a marvellous work among this people, [even] a marvellous work and a wonder: _for the wisdom of their wise [men] shall perish, and the understanding of their prudent [men] shall be hid_.

Isaiah 29:15 _Woe unto them that seek deep to hide their counsel from the LORD, and their works are in the dark, and they say, Who seeth us? and who knoweth us? _

Isaiah 29:16 _Surely your turning of things upside down shall be esteemed as the potter's clay: for shall the work say of him that made it, He made me not? or shall the thing framed say of him that framed it, He had no understanding? _

Isaiah 29:17 [Is] it not yet a very little while, and Lebanon shall be turned into a fruitful field, and the fruitful field shall be esteemed as a forest?

Isaiah 29:18 _And in that day shall the deaf hear the words of the book, _and the eyes of the blind shall see out of obscurity, and out of darkness_.

Isaiah 29:19 _The meek also shall increase [their] joy in the LORD, and the poor among men shall rejoice in the Holy One of Israel. _

Isaiah 29:20 For the terrible one is brought to nought, and _the scorner is consumed, and all that watch for iniquity are cut off: _

Isaiah 29:21 _That make a man an offender for a word, and lay a snare for him that reproveth in the gate, and turn aside the just for a thing of nought_.

Isaiah 29:22 Therefore thus saith the LORD, who redeemed Abraham, concerning the house of Jacob, Jacob shall not now be ashamed, neither shall his face now wax pale.

Isaiah 29:23 But when he seeth his children, the work of mine hands, in the midst of him, they shall sanctify my name, and sanctify the Holy One of Jacob, and shall fear the God of Israel.

Isaiah 29:24 _They also that erred in spirit shall come to

understanding, and they that murmured shall learn doctrine._

Isaiah 30:1 _Woe to the rebellious children, saith the LORD, that take counsel, but not of me;_ and that cover with a covering, but not of my spirit, that they may add sin to sin:

Isaiah 30:2 _That walk to go down into Egypt_, and have not asked at my mouth; to strengthen themselves in the strength of Pharaoh, and _to trust in the shadow of Egypt_!

Isaiah 30:3 Therefore shall the strength of Pharaoh be your shame, and _the trust in the shadow of Egypt [your] confusion_.

NIMROD

Genesis 10:8 And Cush begat Nimrod: he began to be a mighty one in the earth.

I Chronicles 1:10 And Cush begat Nimrod: he began to be mighty upon the earth.

Micah 5:6 And they shall waste the land of Assyria with the sword, and the land of Nimrod in the entrances thereof: thus shall he deliver [us] from the Assyrian, when he cometh into our land, and when he treadeth within our borders.

Ezekiel 8:14 Then he brought me to the door of the gate of the LORD'S house which [was] toward the north; and, behold, there sat women weeping for Tammuz.

I Kings 11:5 For Solomon went after Ashtoreth the goddess of the Zidonians, and after Milcom the abomination of the Ammonites.

Joshua 12:4 And the coast of Og king of Bashan, [which was] of the remnant of the giants, that dwelt at Ashtaroth and at Edrei,

Joshua 13:12 All the kingdom of Og in Bashan, which reigned in Ashtaroth and in Edrei, who remained of the remnant of the giants: for these did Moses smite, and cast them out.

Judges 10:6 And the children of Israel did evil again in the sight of the LORD, and served Baalim, and Ashtaroth, and the gods of Syria, and the gods of Zidon, and the gods of Moab, and the gods of the children of Ammon, and the gods of the Philistines, and forsook the LORD, and served not him.

I Samuel 7:4 Then the children of Israel did put away Baalim and Ashtaroth, and served the LORD only.

Acts 19:35 And when the townclerk had appeased the people, he said, [Ye] men of Ephesus, what man is there that knoweth not how that the city of the Ephesians is a worshipper of the great goddess Diana, and of the [image] which fell down from Jupiter?

Genesis 6:4 There were giants in the earth in those days; and also after that, when the sons of God came in unto the daughters of men, and they bare [children] to them, the same [became] mighty men which [were] of old, men of renown.

Numbers 13:33 And there we saw the giants, the sons of Anak, [which come] of the giants: and we were in our own sight as grasshoppers, and so we were in their sight.

Deuteronomy 2:11 Which also were accounted giants, as the Anakims; but the Moabites call them Emims.

Deuteronomy 2:20 (That also was accounted a land of giants: giants dwelt therein in old time; and the Ammonites call them Zamzummims;

Deuteronomy 3:11 For only Og king of Bashan remained of the remnant of giants; behold, his bedstead [was] a bedstead of iron; [is] it not in Rabbath of the children of Ammon? nine cubits [was] the length thereof, and four cubits the breadth of it, after the cubit of a man.

Deuteronomy 3:13 And the rest of Gilead, and all Bashan, [being] the kingdom of Og, gave I unto the half tribe of Manasseh; all the region of Argob, with all Bashan, which was called the land of giants.

Joshua 12:4 And the coast of Og king of Bashan, [which was] of the remnant of the giants, that dwelt at Ashtaroth and at Edrei,

Joshua 13:12 All the kingdom of Og in Bashan, which reigned in Ashtaroth and in Edrei, who remained of the remnant of the giants: for these did Moses smite, and cast them out.

Joshua 15:8 And the border went up by the valley of the son of Hinnom unto the south side of the Jebusite; the same [is] Jerusalem: and the border went up to the top of the mountain that [lieth] before the valley of Hinnom westward, which [is] at the end of the valley of the giants northward:

Joshua 17:15 And Joshua answered them, If thou [be] a great people, [then] get thee up to the wood [country], and cut down for thyself there in the land of the Perizzites and of the

giants, if mount Ephraim be too narrow for thee.

Joshua 18:16 And the border came down to the end of the mountain that [lieth] before the valley of the son of Hinnom, [and] which [is] in the valley of the giants on the north, and descended to the valley of Hinnom, to the side of Jebusi on the south, and descended to En-rogel,

II Chronicles 33:6 And he caused his children to pass through the fire in the valley of the son of Hinnom: also he observed times, and used enchantments, and used witchcraft, and dealt with a familiar spirit, and with wizards: he wrought much evil in the sight of the LORD, to provoke him to anger.

Judges 2:13 And they forsook the LORD, and served Baal and Ashtaroth.

SOLOMON

I Kings 11:5 For Solomon went after Ashtoreth the goddess of the Zidonians, and after Milcom the abomination of the Ammonites.

I Kings 11:6 And Solomon did evil in the sight of the LORD, and went not fully after the LORD, as [did] David his father.

I Kings 11:7 Then did Solomon build an high place for Chemosh, the abomination of Moab, in the hill that [is] before Jerusalem, and for Molech, the abomination of the children of Ammon.

I Kings 11:8 And likewise did he for all his strange wives, which burnt incense and sacrificed unto their gods.

DECEPTION

II Thessalonians 2:3 Let no man deceive you by any means: for [that day shall not come], except there come a falling away first, and that man of sin be revealed, the son of perdition;

II Thessalonians 2:4 Who opposeth and exalteth himself above all that is called God, or that is worshipped; so that he as God sitteth in the temple of God, shewing himself that he is God.

II Thessalonians 2:5 Remember ye not, that, when I was yet with you, I told you these things?

II Thessalonians 2:6 And now ye know what withholdeth that he might be revealed in his time.

II Thessalonians 2:7 For the mystery of iniquity doth already work: only he who now letteth [will let], until he be taken out

of the way.

II Thessalonians 2:8 And then shall that Wicked be revealed, whom the Lord shall consume with the spirit of his mouth, and shall destroy with the brightness of his coming:

II Thessalonians 2:9 [Even him], whose coming is after the working of Satan with all power and signs and lying wonders,

II Thessalonians 2:10 And with all deceivableness of unrighteousness in them that perish; because they received not the love of the truth, that they might be saved.

II Thessalonians 2:11 And for this cause God shall send them strong delusion, that they should believe a lie:

II Thessalonians 2:12 That they all might be damned who believed not the truth, but had pleasure in unrighteousness.

Matthew 7:13 Enter ye in at the strait gate: for wide [is] the gate, and broad [is] the way, that leadeth to destruction, and many there be which go in thereat:

Matthew 7:14 Because strait [is] the gate, and narrow [is] the way, which leadeth unto life, and few there be that find it.

Matthew 7:15 Beware of false prophets, which come to you in sheep's clothing, but inwardly they are ravening wolves.

Matthew 7:16 Ye shall know them by their fruits. Do men gather grapes of thorns, or figs of thistles?

Matthew 7:17 Even so every good tree bringeth forth good fruit; but a corrupt tree bringeth forth evil fruit.

Matthew 7:18 A good tree cannot bring forth evil fruit, neither [can] a corrupt tree bring forth good fruit.

Matthew 7:19 Every tree that bringeth not forth good fruit is hewn down, and cast into the fire.

Matthew 7:20 Wherefore by their fruits ye shall know them.

Matthew 7:21 Not every one that saith unto me, Lord, Lord, shall enter into the kingdom of heaven; but he that doeth the will of my Father which is in heaven.

Matthew 7:22 Many will say to me in that day, Lord, Lord, have we not prophesied in thy name? and in thy name have cast out

devils? and in thy name done many wonderful works?

Matthew 7:23 And then will I profess unto them, I never knew you: depart from me, ye that work iniquity.

Matthew 7:24 Therefore whosoever heareth these sayings of mine, and doeth them, I will liken him unto a wise man, which built his house upon a rock:

Matthew 7:25 And the rain descended, and the floods came, and the winds blew, and beat upon that house; and it fell not: for it was founded upon a rock.

Matthew 7:26 And every one that heareth these sayings of mine, and doeth them not, shall be likened unto a foolish man, which built his house upon the sand:

Matthew 7:27 And the rain descended, and the floods came, and the winds blew, and beat upon that house; and it fell: and great was the fall of it.

II Corinthians 11:15 Therefore [it is] no great thing if his ministers also be transformed as the ministers of righteousness; whose end shall be according to their works.

Romans 3:11 There is none that understandeth, there is none that seeketh after God.

Romans 3:12 They are all gone out of the way, they are together become unprofitable; there is none that doeth good, no, not one.

Romans 3:13 Their throat [is] an open sepulchre; with their tongues they have used deceit; the poison of asps [is] under their lips:

Ephesians 4:14 That we [henceforth] be no more children, tossed to and fro, and carried about with every wind of doctrine, by the sleight of men, [and] cunning craftiness, whereby they lie in wait to deceive;

II Corinthians 11:13 For such [are] false apostles, deceitful workers, transforming themselves into the apostles of Christ.

Ephesians 5:6 Let no man deceive you with vain words: for because of these things cometh the wrath of God upon the children of disobedience.

Colossians 2:8 Beware lest any man spoil you through philosophy and vain deceit, after the tradition of men, after the rudiments

of the world, and not after Christ.

II Timothy 3:13 But evil men and seducers shall wax worse and worse, deceiving, and being deceived.

II John 1:7 For many deceivers are entered into the world, who confess not that Jesus Christ is come in the flesh. This is a deceiver and an antichrist.

Matthew 15:14 Let them alone: they be blind leaders of the blind. And if the blind lead the blind, both shall fall into the ditch.

Isaiah 29:16 Surely your turning of things upside down shall be esteemed as the potter's clay: for shall the work say of him that made it, He made me not? or shall the thing framed say of him that framed it, He had no understanding?

II Timothy 3:1 This know also, that in the last days perilous times shall come.

II Timothy 3:2 For men shall be lovers of their own selves, covetous, boasters, proud, blasphemers, disobedient to parents, unthankful, unholy,

II Timothy 3:3 Without natural affection, trucebreakers, false accusers, incontinent, fierce, despisers of those that are good,

II Timothy 3:4 Traitors, heady, highminded, lovers of pleasures more than lovers of God;

II Timothy 3:5 Having a form of godliness, but denying the power thereof: from such turn away.

II Timothy 3:7 Ever learning, and never able to come to the knowledge of the truth.

II Timothy 3:8 Now as Jannes and Jambres withstood Moses, so do these also resist the truth: men of corrupt minds, reprobate concerning the faith.

II Timothy 3:9 But they shall proceed no further: for their folly shall be manifest unto all [men], as theirs also was.

Ephesians 4:17 This I say therefore, and testify in the Lord, that ye henceforth walk not as other Gentiles walk, in the vanity of their mind,

Matthew 24:24 For there shall arise false Christs, and false

prophets, and shall shew great signs and wonders; insomuch that, if [it were] possible, they shall deceive the very elect.

Acts 16:16 And it came to pass, as we went to prayer, a certain damsel possessed with a spirit of divination met us, which brought her masters much gain by soothsaying:

WISDOM

I Corinthians 1:18 For the preaching of the cross is to them that perish foolishness; but unto us which are saved it is the power of God.

I Corinthians 1:19 For it is written, I will destroy the wisdom of the wise, and will bring to nothing the understanding of the prudent.

I Corinthians 1:20 Where [is] the wise? where [is] the scribe? where [is] the disputer of this world? hath not God made foolish the wisdom of this world?

I Corinthians 1:21 For after that in the wisdom of God the world by wisdom knew not God, it pleased God by the foolishness of preaching to save them that believe.

I Corinthians 1:25 Because the foolishness of God is wiser than men; and the weakness of God is stronger than men.

I Corinthians 3:19 For the wisdom of this world is foolishness with God. For it is written, He taketh the wise in their own craftiness.

II Corinthians 4:3 But if our gospel be hid, it is hid to them that are lost:

II Corinthians 4:4 In whom the god of this world hath blinded the minds of them which believe not, lest the light of the glorious gospel of Christ, who is the image of God, should shine unto them.

James 1:5 If any of you lack wisdom, let him ask of God, that giveth to all [men] liberally, and upbraideth not; and it shall be given him.

Proverbs 3:5 Trust in the LORD with all thine heart; and lean not unto thine own understanding.

Proverbs 3:7 Be not wise in thine own eyes: fear the LORD, and depart from evil.

Proverbs 12:15 The way of a fool [is] right in his own eyes: but he that hearkeneth unto counsel [is] wise.

Proverbs 26:12 Seest thou a man wise in his own conceit? [there is] more hope of a fool than of him.

Isaiah 5:21 Woe unto [them that are] wise in their own eyes, and prudent in their own sight!

Jeremiah 9:23 Thus saith the LORD, Let not the wise [man] glory in his wisdom, neither let the mighty [man] glory in his might, let not the rich [man] glory in his riches:

Romans 1:22 Professing themselves to be wise, they became fools,

Proverbs 14:8 The wisdom of the prudent [is] to understand his way: but the folly of fools [is] deceit.

Proverbs 1:7 The fear of the LORD [is] the beginning of knowledge: [but] fools despise wisdom and instruction.

Proverbs 2:7 He layeth up sound wisdom for the righteous: [he is] a buckler to them that walk uprightly.

James 1:5 If any of you lack wisdom, let him ask of God, that giveth to all [men] liberally, and upbraideth not; and it shall be given him.

I John 5:20 And we know that the Son of God is come, and hath given us an understanding, that we may know him that is true, and we are in him that is true, [even] in his Son Jesus Christ. This is the true God, and eternal life.

NOT WORKS -GRACE

Ephesians 2:8 For by grace are ye saved through faith; and that not of yourselves: [it is] the gift of God:

Ephesians 2:9 Not of works, lest any man should boast.

I Corinthians 6:11 And such were some of you: but ye are washed, but ye are sanctified, but ye are justified in the name of the Lord Jesus, and by the Spirit of our God.

Romans 3:10 As it is written, There is none righteous, no, not one:

Leviticus 26:40 If they shall confess their iniquity, and the iniquity of their fathers, with their trespass which they

trespassed against me, and that also they have walked contrary unto me;

Romans 5:20 Moreover the law entered, that the offence might abound. But where sin abounded, grace did much more abound:

Romans 5:21 That as sin hath reigned unto death, even so might grace reign through righteousness unto eternal life by Jesus Christ our Lord.

SALVATION THROUGH CHRIST ALONE

Acts 4:12 Neither is there salvation in any other: for there is none other name under heaven given among men, whereby we must be saved.

John 14:6 Jesus saith unto him, I am the way, the truth, and the life: no man cometh unto the Father, but by me.

John 5:23 That all [men] should honour the Son, even as they honour the Father. He that honoureth not the Son honoureth not the Father which hath sent him.

John 5:24 Verily, verily, I say unto you, He that heareth my word, and believeth on him that sent me, hath everlasting life, and shall not come into condemnation; but is passed from death unto life.

John 3:16 For God so loved the world, that he gave his only begotten Son, that whosoever believeth in him should not perish, but have everlasting life.

John 3:17 For God sent not his Son into the world to condemn the world; but that the world through him might be saved.

Ephesians 4:15 But speaking the truth in love, may grow up into him in all things, which is the head, [even] Christ:

BE BORN AGAIN

John 3:3 Jesus answered and said unto him, Verily, verily, I say unto thee, Except a man be born again, he cannot see the kingdom of God.

John 3:5 Jesus answered, Verily, verily, I say unto thed places straight: I will break in pieces the gates of brass, and cut in sunder the bars of iron:

LACK OF KNOWLEDGE

Hosea 4:6 My people are destroyed for lack of knowledge: because thou hast rejected knowledge, I will also reject thee, that thou shalt be no priest to me: seeing thou hast forgotten the law of thy God, I will also forget thy children.

IDOLS - OTHER GODS

Deuteronomy 6:14 Ye shall not go after other gods, of the gods of the people which [are] round about you;

Deuteronomy 6:15 (For the LORD thy God [is] a jealous God among you) lest the anger of the LORD thy God be kindled against thee, and destroy thee from off the face of the earth.

Exodus 23:32 Thou shalt make no covenant with them, nor with their gods.

Numbers 25:5 And Moses said unto the judges of Israel, Slay ye every one his men that were joined unto Baal-peor.

Deuteronomy 7:4 For they will turn away thy son from following me, that they may serve other gods: so will the anger of the LORD be kindled against you, and destroy thee suddenly.

II Corinthians 6:15 And what concord hath Christ with Belial? or what part hath he that believeth with an infidel?

II Corinthians 6:16 And what agreement hath the temple of God with idols? for ye are the temple of the living God; as God hath said, I will dwell in them, and walk in [them]; and I will be their God, and they shall be my people.

OTHER PRACTICES

Galatians 5:20 Idolatry, witchcraft, hatred, variance, emulations, wrath, strife, seditions, heresies,

Deuteronomy 18:9 When thou art come into the land which the LORD thy God giveth thee, thou shalt not learn to do after the abominations of those nations.

Isaiah 44:25 That frustrateth the tokens of the liars, and maketh diviners mad; that turneth wise [men] backward, and maketh their knowledge foolish;

Isaiah 47:12 Stand now with thine enchantments, and with the multitude of thy sorceries, wherein thou hast laboured from thy youth; if so be thou shalt be able to profit, if so be thou mayest prevail.

Jeremiah 10:2 Thus saith the LORD, Learn not the way of the heathen, and be not dismayed at the signs of heaven; for the heathen are dismayed at them.

GODS JUDGMENT

Genesis 6:5 And God saw that the wickedness of man [was] great in the earth, and [that] every imagination of the thoughts of his heart [was] only evil continually.

Genesis 6:6 And it repented the LORD that he had made man on the earth, and it grieved him at his heart.

Genesis 6:7 And the LORD said, I will destroy man whom I have created from the face of the earth; both man, and beast, and the creeping thing, and the fowls of the air; for it repenteth me that I have made them.

Genesis 19:13 For we will destroy this place, because the cry of them is waxen great before the face of the LORD; and the LORD hath sent us to destroy it.

Deuteronomy 28:58 If thou wilt not observe to do all the words of this law that are written in this book, that thou mayest fear this glorious and fearful name, THE LORD THY GOD;

Deuteronomy 28:59 Then the LORD will make thy plagues wonderful, and the plagues of thy seed, [even] great plagues, and of long continuance, and sore sicknesses, and of long continuance.

Deuteronomy 28:60 Moreover he will bring upon thee all the diseases of Egypt, which thou wast afraid of; and they shall cleave unto thee.

Deuteronomy 28:61 Also every sickness, and every plague, which [is] not written in the book of this law, them will the LORD bring upon thee, until thou be destroyed.

Isaiah 28:13 But the word of the LORD was unto them precept upon precept, precept upon precept; line upon line, line upon line; here a little, [and] there a little; that they might go, and fall backward, and be broken, and snared, and taken.

Isaiah 47:9 But these two [things] shall come to thee in a

moment in one day, the loss of children, and widowhood: they shall come upon thee in their perfection for the multitude of thy sorceries, [and] for the great abundance of thine enchantments.

Isaiah 47:9 But these two [things] shall come to thee in a moment in one day, the loss of children, and widowhood: they shall come upon thee in their perfection for the multitude of thy sorceries, [and] for the great abundance of thine enchantments.

Isaiah 47:10 For thou hast trusted in thy wickedness: thou hast said, None seeth me. Thy wisdom and thy knowledge, it hath perverted thee; and thou hast said in thine heart, I [am], and none else beside me.

Isaiah 47:11 Therefore shall evil come upon thee; thou shalt not know from whence it riseth: and mischief shall fall upon thee; thou shalt not be able to put it off: and desolation shall come upon thee suddenly, [which] thou shalt not know.

Malachi 3:5 And I will come near to you to judgment; and I will be a swift witness against the sorcerers, and against the adulterers, and against false swearers, and against those that oppress the hireling in [his] wages, the widow, and the fatherless, and that turn aside the stranger [from his right], and fear not me, saith the LORD of hosts.

3 - 4 GENERATIONS

Exodus 20:5 Thou shalt not bow down thyself to them, nor serve them: for I the LORD thy God [am] a jealous God, visiting the iniquity of the fathers upon the children unto the third and fourth [generation] of them that hate me;

BURN IT

Acts 19:19 Many of them also which used curious arts brought their books together, and burned them before all [men]: and they counted the price of them, and found [it] fifty thousand [pieces] of silver.

CHASTISING

Proverbs 3:12 For whom the LORD loveth he correcteth; even as a father the son [in whom] he delighteth.

Romans 8:18 For I reckon that the sufferings of this present time [are] not worthy [to be compared] with the glory which shall be revealed in us.

II Timothy 3:12 Yea, and all that will live godly in Christ Jesus shall suffer persecution.

Hebrews 12:6 For whom the Lord loveth he chasteneth, and scourgeth every son whom he receiveth.

Hebrews 12:7 If ye endure chastening, God dealeth with you as with sons; for what son is he whom the father chasteneth not?

James 5:11 Behold, we count them happy which endure. Ye have heard of the patience of Job, and have seen the end of the Lord; that the Lord is very pitiful, and of tender mercy.

Revelation 3:19 As many as I love, I rebuke and chasten: be zealous therefore, and repent.

BE SEPRATED

Psalms 1:1 Blessed [is] the man that walketh not in the counsel of the ungodly, nor standeth in the way of sinners, nor sitteth in the seat of the scornful.

Psalms 26:4 I have not sat with vain persons, neither will I go in with dissemblers.

Proverbs 4:15 Avoid it, pass not by it, turn from it, and pass away.

Proverbs 9:6 Forsake the foolish, and live; and go in the way of understanding.

I Corinthians 5:11 But now I have written unto you not to keep company, if any man that is called a brother be a fornicator, or covetous, or an idolater, or a railer, or a drunkard, or an extortioner; with such an one no not to eat.

II Corinthians 6:14 Be ye not unequally yoked together with unbelievers: for what fellowship hath righteousness with unrighteousness? and what communion hath light with darkness?

II Corinthians 6:17 _Wherefore come out from among them, and be ye separate, saith the Lord, and touch not the unclean [thing]; and I will receive you,_

Ephesians 5:11 And have no fellowship with the unfruitful works

of darkness, but rather reprove [them].

II Thessalonians 3:6 Now we command you, brethren, in the name of our Lord Jesus Christ, that ye withdraw yourselves from every brother that walketh disorderly, and not after the tradition which he received of us.

II Thessalonians 3:14 And if any man obey not our word by this epistle, note that man, and have no company with him, that he may be ashamed.

II Thessalonians 3:15 Yet count [him] not as an enemy, but admonish [him] as a brother.

Revelation 18:4 And I heard another voice from heaven, saying, Come out of her, my people, that ye be not partakers of her sins, and that ye receive not of her plagues.

Revelation 2:2 I know thy works, and thy labour, and thy patience, and how thou canst not bear them which are evil: and thou hast tried them which say they are apostles, and are not, and hast found them liars:

Romans 12:2 And be not conformed to this world: but be ye transformed by the renewing of your mind, that ye may prove what [is] that good, and acceptable, and perfect, will of God.

I John 2:15 Love not the world, neither the things [that are] in the world. If any man love the world, the love of the Father is not in him.

I John 2:16 For all that [is] in the world, the lust of the flesh, and the lust of the eyes, and the pride of life, is not of the Father, but is of the world.

John 3:8 The wind bloweth where it listeth, and thou hearest the sound thereof, but canst not tell whence it cometh, and whither it goeth: so is every one that is born of the Spirit.

GATES OF BRASS

Psalms 107:16 For he hath broken the gates of brass, and cut the bars of iron in sunder.

Isaiah 45:2 I will go before thee, and make the crooked places straight: I will break in pieces the gates of brass, and cut in sunder the bars of iron:

DEMIT TO THE LODGE

Date _____

Own Address

The Masters, Officers, and members
Lodge _____ No _____

Gentlemen,

It is with regret that I submit my resignation from your lodge, and from all Masonic bodies. I Have taken this step in spite of the fact that I value very much the friendships and associations I have developed within masonry over the years. ²³

When initiated into the Entered Apprentice Degree, I was prompted to swear, *"I will always hail, ever conceal and never reveal any of the secret arts, parts or points of the (supposed) hidden mysteries of Ancient Masonry, which have heretofore, may at this time or shall at any further period be communicated to me as such."* In my ignorance, and being led along line by line, I indulged in the bloody obligation required of me without questioning it.

Now, after having examined the highest documents and authorities of Freemasonry²⁴. And after having found beyond any doubt that the god of Freemasonry is positively not the God of the Bible²⁵. And that Freemasonry is in no way compatible with or complimentary to Biblical Christianity²⁶, I have chosen my course of action.

Being a disciple and student of the Words, Ways and Person of the only Lord and Saviour Jesus Christ. And confessing His Lordship over my life, as I do, and having learned the true purpose, intent and nature of Freemasonry²⁷, as well as the true interpretation of it's borrowed symbols. I present to you my **irrevocable notice of withdrawal from and demit to the fraternity.**

²³ Matthew 10:37

²⁴ A massive compendium of Masonic authority which includes A Pike "Morals and Dogma" Mackey, M P Hall, Waite, Schnoebelen (33rd deg. Esoteric 95th deg.), J Harris (33rd deg.), The Masonic dictionaries, videos, commentaries etc. And the Bible for comparison

²⁵ Pike and many others identify him as *the Son of Morning* (the Sun) Ra, Baal (Kabal) , Lucifer.

²⁶ See summary attached

²⁷ To be initiated at the end into the Illumination of light the *Ain Soph Aur* of Lucis (Lucifer)

As a disciple of Christ I utterly and irrevocably renounce my association and my imagined obligation to Freemasonry without the least equivocation, mental reservation, or self-evasion of mind, and do this gentlemen because of the infallible word of God²⁸.

Please believe me gentlemen, I hold no animosity toward you, or any other man in the Lodge. It is not you who deceived us all. It is the adepts and sages, the princes (the Thirty Third Degree Council and above) who know that the designs and purpose of Freemasonry are to control unsuspecting men through a system of deception, intrigue and error²⁹.

Unfortunately, in spite of the fraternal love I bear you all, I find that in following Jesus Christ, I must sever my ties with all forms of the Masonic fraternity³⁰. This is no reflection upon you, or upon the many good things that Masonry does. It is simply the fact that Masonry does not honour Jesus Christ as the almighty God who came in the flesh to save us from our sins.³¹

I take my Masonic obligations very seriously, and for that reason, I realise the cable tow was a powerful yoke that bound me to many Masons who do not worship the true God or His son Jesus, however sincere they may be in their devotions. I must take the commands of my God more seriously. However, one whom I love more than all of you has said, "He that loveth father or mother more than me is not worthy of me and he that loveth son or daughter more than me is not worthy of me." The Bible is truly the great light and as of now the only trustworthy authority on the subject of light and darkness and it shows me:- *Be ye not unequally yoked together with unbelievers; for what fellowship has light with darkness? Or what harmony has Christ with Belial (the devil), or what has a believer in common with an unbeliever? Or what agreement has the temple of God with idols? For we are the temple of the living God; just as God said, "I will dwell in them and walk among them; and I will be their God, and they shall be my people. Therefore, come out from among their midst and be ye separate, says the Lord. Do not touch what is unclean; and I will welcome you."*³² To remain in Masonry, is to compromise my fellowship with Jesus who died for me.³³

I only pray that you too will see the true light and come out of darkness³⁴. To this end I have attached a short summary of the incompatibilities between Biblical Christianity and Masonry. Those of you that believe that the Bible is the Inspired word of God³⁵ and give it that respect as one of the "three great lights" need to consider that annexure and make your own decision.

God bless you as you seek His way in this important matter.

Respectfully,

²⁸ II Corinthians 6: 14-17

²⁹ See *Morals and Dogma* by Pike page 104 - 105 & 819

³⁰ *ibid.* note 6

³¹ John 3:16, 17, Acts 4:12, John 14:6

³² (II Corinthians 6: 14-17)

³³ *ibid.* note 6

³⁴ John 8:12, Ephesians 5:14, II Corinthians 11:14, II Corinthians. 4:6, Acts 26:18

³⁵ What with so many prophecies (4500 out of 4700) having been (and still being) fulfilled, one must be crazy not to identify it as God's word, else how could history, to this day, still be tailored to fit a 5,000 year old document exactly (and at that, in a secular world).

BIBLIOGRAPHY

MASONIC

1. "Morals and Dogma of the Ancient and Accepted Scottish Rite of Freemasonry" 1966 page 260 by Albert Pike 33 deg, Sovereign Grand Pontiff General of Universal Freemasonry
2. The Deadly Deception by Jim Shaw ex 33rd deg Mason
3. Masonry Beyond the Light by William Schnoebelen ISBN 0-937958-38-7 Chick publications P.O Box 662 Chino, CA 91708-0662 1991
4. Lodges Examined by the Bible by John Rice The Character Claims and Practical Workings of Freemasonry
5. The Masonic Report by C.F McQuig, Freemasonry proceeds from the Kaballa, oaths, real occultic beliefs 33rd degree expose
6. Botha Inquiry 1965 Commission of Inquiry into Secret Societies
7. Illustrations of Freemasonry by Cpat WM Morgan 1827 - was killed by freemasons - they freely admitted it and still quote it as an example of what can happen if you expose the order. TheAnti Masons Party of the USA started because of this book.
8. The Truth about Masons by Dr. Robert Morey ISBN 1-56507-077-1 Harvest House Publishers Eugene, Oregon 97402 1993 "Dr. Robert Morey is the director of the Research and Education Foundation, a group dedicated to researching topics affecting Western Culture. He is a respected researcher of more than 20 books."
9. The Gods of the Lodge, Reginald Haupt
10. The Encyclopaedia of Freemasonry by A.G. Mackey, 33 deg M.D., McClure Publishing Co., Philadelphia, 1966 pg 601 pg 8-9
11. R.S Clymer, The Mysticism of Masonry (1900) p 47:
12. 'Ancient Freemasonry' by Frank C. Higgins, 32 Deg. Printers: 1923 Pyramid Book Co. N.Y..., Page 12
13. What you need to know about the Masons by Ed Decker, Harvest House Publishers Eugene, Oregon 97402 ISBN 0-89081-945-9
14. Inside the Brotherhood by Martin Short Grafton Books a division of Collins publishing 8 Grafton street london ISBN 0-586- 07065-6
15. The Holy Grail
16. The Diary of a Freed Mason by David W.M. Vaughan ISBN 1-85240-013-7 Anchor brendon Ltd, Tiptree Essex, Hodder & Stoughton, M R Reprographics, 42 high Street chard, Somerset TA 20 1Qs 1977
17. 'Freemasonry' by Rev C.G. Finney available through 'Christian truth and victory Publications' 9088 CO. RD. 11N.W., Alexandria, MN 56308, Phone: (612) 846-0835. Refer questions to rev. Jim Shaw. an ex 33rd degree free mason, box 884, Silver Springs, FL 32688
18. 'The Scottish Workings of Craft Masonry' published by A Lewis (Masonic Publishers) Ltd, Surrey, 1982 edition and
19. The Brotherhood by Stephen Knight ISBN 0-586 05983-0 Granada Publishing Ltd, 8 Grafton street, london W1X 3la 1985. This book sparked an official investigation and Commission of Inquiry in England.
20. 'The Complete Workings of and Craft Freemasonry' by the same publishers

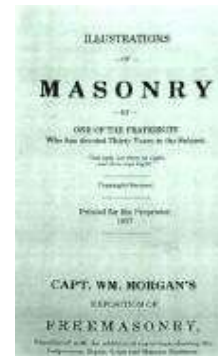

21. Duncan's Masonic Ritual and Monitor, the official Freemasons guide to symbolic Degrees.

22. Practice and Procedure for the Scottish Rite 1981 pp 75-77 Henry Clausen 33 deg

23. R.S Clymer, The Mysticism of Masonry (1900) p 47:

24. J.D. Buck 'Symbolism of Mystic Masonry (1925) p 57

25. Freemasonry a Religion by John Lawrence ISBN 0 86065 447 8 Kingsway Publications Ltd Iottbridge Drove, Eastboarn, E Sussex BN23 6NT by Richard Clay Ltd, Bungay, Suffolk and CST, Eastboarne, E. Sussex 1973



26. The Masters Carpet by Edmonde Ronyane Available through Christian Truth and Victory Publications 161 Sylan lane N.E. Fridlay, MN 55432

27. Born in Blood by John J. Robinson ISBN 0-09-922861-0

28. The Hidden Power Behind Freemasonry Lt. Col Jack Mohr

29. Inside Freemasonry. The most illuminating investigation yet published of the evolution of Freemasonry. An historical detective story tracing the flight after 1309 of the Knights Templar from Europe to Scotland outlining sections such as Scotland and a Hidden Tradition, The origins of Freemasonry and Freemasonry and American Independence. ISBN 0-552-1356-8



30. The Temple and the Lodge by Michael Baigent & Richard Leigh. Inside Freemasonry. The most illuminating investigation yet published of the evolution of Freemasonry. An historical detective story tracing the flight after 1309 of the Knights Templar from Europe to Scotland outlining sections such as Scotland and a Hidden Tradition, The origins of Freemasonry and Freemasonry and American Independence. ISBN 0-552-1356-8

31. I Left The Lodge by Dale A. Byers.... A former Mason, from the viewpoint of an insider, shows that Masonry is neither as innocent nor noble as it appears. Published by REGULAR BAPTIST PRESS, 1300 North Meacham Road, Schaumburg, Illinois 60173-4888. ISBN 0-87227-127-7.

32. Christ, The Christian and Freemasonry by W.J. McK. McCormick. Published by Grat Joy Publications, 12, Ballynahinch Rd, Carryduff, Belfast, BT8 8DN. Disclosing amongst all other aspects, the various degrees and Oaths of Secret Societies and how they fit into Law and Order.

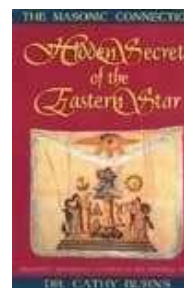

33. Names of some prominent individuals who have spoken out against :

34. Chief Justice Charles Marshall, Alexander Cambell, Daniel , Wendell Phillips, John Wesley, Horace Greeley, Dwight . moody, R.A. Torrey, Timothy Dwight, Charles Finney, Charles , John Adams, John Quincy Adams, John Madison, Amos , Simon Peter Long, James M. Gray.

Newsletters

35. Research & Education Foundation, Dr. Robert Morey, P.O.Box , Austin,TX,78714

36. Ministries for Freemasons

37. Free the Masons Ministries, Edward J Decker P.O.Box 1077, Issaquah, WA,98027, U.S.A. Tel (206) 392-2077, From 'Beyond the Light'

38. Jim,,Shaw P.O. Box 884, Silver Springs, FL,32688-0884, U.S.A., (Evangelist) (Ex 33deg Mason)

39. HRT Ministries, Rev. Harmon Taylor, P.O. Box 43, Redford, NY, -0043, U.S.A. (Ex Mason, "Grand Chaplain", New York State")

40. In His Grip Ministries, Mick Oxley, P.O. Box 257-E- Rt#1, City, FL,32012, Tel (904) 649-5361,00/00/00 Ex Master ,

Video tapes

41. 'What Goes on Behind Closed Doors' by Jack Harris through Preach the Word Ministries (PTW) This video tape contains full re-enactment of Masonic rituals, complete with regalia and props, accompanied by an authoritative commentary on the proceedings.
42. "Freemasonry" Franky Schaeffer Video Productions, Inc P O Box 909 Los Gatos, CA 95031 Tel (408) 395 1785

NEW WORLD ORDER

43. Conspirators Hierarchy, the story of the Committee of 300 Dr. John Coleman
44. One World Under Anti-Christ by Peter Lalonde
45. Global Tyranny Step by Step .by William F Jasper
46. Volksverraad By Adv Piet Pretorius MI6 infiltrated Military Intelligence and CIA National Intelligence and our leaders such as Pik Botha (CIA Agent). Die broederbond, the NGK, Kodesa, the VF, CP, NP and DP moles are exposed.
47. A History of Communism in South Africa by Henry R. Pike, Christian Mission International, South Africa, ISBN 0-620-08194-5. Shows that Adv Chaskalson now Judge president of the Constitutional Court of South Africa represented arch Communist Braam Fischer and the NUSAS trials, (described in the newspapers as an 'activist' through legalism). F.W de Klerk defended Mandella. Didcott J (now Constitutional Court Judge) tried to ban this book as he is mentioned.
48. En Route to Global Occupation by Gary H. Kah ISBN 0-910311-97-8 Huntington House Publishers P O box 53788 Lafayette, Louisiana 70505 1992
49. Behold a Pale Horse by Milton William Coopers ISBN 0-929385-22-5
50. The New World Order by Ralph Epstein Publius press Philanea Plc 10050 Tuscon Arizona 85730 ISBN 0-9614135-1-4 April 1991
51. Warning, Second Warning, Final Notice by Barry Smith, Priv press
52. Satan's Angels Exposed by Salem Kirban ISBN 0-912582-32-4
53. Understanding the New World Order by Roy Livesey ISBN 0947852263
54. New World Order William T Still ISBN 0910311641
55. Diplomacy By Deception Dr. John Coleman
56. Report from Iron Mountain (1967) Exposes how the powers that be utilize "Crisis Management techniques" on nation states in order to keep their grip on their manipulative control
57. Secret and Suppressed Jim Keith
58. Tomorrow Is Another Country , Allister Sparks, exposes exactly what went on behind the scenes during Codesa and the birth of the new South Africa.
59. Syndrome of Control , by Lindsay Williams
60. Collective Speeches Of Congressman Louis T Mc Fadden
61. Circle Of Intrigue by Texxe Marrs
62. Black Helicopters Over America , Jim Keith.
63. The Perestroika Deception , Anatoliy Golitsyn Nobody should be fooled into thinking Communism is dead after reading this book by this absolute Authority on the subject.

64. The World Conspiracy , Nicola M. Nicolov
65. The New Money System Mary Stewart Rolphe Phd ISBN 0908421-05-2 Details of the planned one world money system
66. A Century Of War: Anglo American Oil Politics and the new World Order William Engdahl
67. The Fourth Reich of the Rich by Des Griffin
68. The Controversy of Zion , by Douglas Reed. Most judges will quote only the Swiss Supreme Court case on the issue, not the appellate Division case when the protocols were creditised.
69. Empire of the City - World Superstate E.C. Knuth
70. The Naked Capatalist , W. Cleon Skousen
71. The Zionist factor : The Jewish Impact on 20th century History, Ivor Benson
72. Behind the Balfour Declaration , Robert John Phd
73. The Anglo American Establishment , by Carrol Quigly Phd
74. The World Conspiracy: What the Historians Don't tell You
75. Dope Incorporated , Executive Intelligence Review
76. Die Jode by W.S. Mc Loud . Samesweerders of Volk van God. 'n Studie van die konflik tussen die rolle van die Jode in ondermynnende bedrywighede en in Bybelprofesiee. Uitgegee deur: W.S. Mc Loud, P.O. Box 71706. Die Wilgers 0041.
77. Henry Kissinger Soviet Agent by Frank A Capel, Herald of Freedom, Zarephath, New jersey
78. Kissinger Man of Peace? by Salem Kirban, Library of Congress No 7479613 ISBN 0-912582-18-9
79. The Rockefeller File . The untold story of the most powerful family in America By Gary Allen. Published by '76 Press, The 'WAKE UP SOUTH AFRICA CAMPAIGN' P.O. Box 50471 New Redruth 1452. Covering topics such as The Sainly Sinner, The Family That Preys Together, The Great Energy Swindle The Eternal Power Behind the Throne and others.
80. Peril in South Africa by Francis Grim covering Pop Festivals, Pornography, Censorship, Sensitivity Training, Infiltration of Education.
81. Attempted Rape of South Africa by Francis Grim. Every South Afrian has the right to know the truth regarding the grave danger threatening our land. Covering Pornography, Communist strategy of infiltration, Drugs, Homosexuality, Satan Worship, How to protest etc., Heart Publishers, P.O. Box 353, Kempton Park, South Afria in collaboration with The Association for the Preservation of Moral Norms, P.O. Box 25082, Monumnet Park, South Africa.
82. The New Unhappy Lords by A.K. Chesterton, published by Hampshire Candour Publishing Co 1975 and distributed by Bloomfield Books, 26 Meadow lane, Sudbury, suffolk England CO10 6TD. An exposure of Power Politics covering Rebellion and War and answering two important questions "What and Who is behind it all". The author was a student of World politics all his life and uncovers closely guarded secrets by international world financiers.
83. World Revolution . by Nesta H. Webster and Edited and Brought up to date by Anthony Gittens. Published by Britons Publishing Company, 1971. The Plot Against Civilization. sbn 85172 427 2
84. Proofs of a Conspiracy by John Robison A.M. 1978. Published by Western Islands, Boston-Los Angeles. Covering Schisms in Free Masonry, The Illuminati, The German Union, The French Revolution.
85. The South African Factor/ Why America is next! by Don McAlvany. Published by M.I.A. Inc. 2320 W. Peoria Avenue Suite c122 Phoenix Arizona 85029.
86. Die Stryd Om Die Wereld , by G.D. Scholtz, Voortrekker Pers Bpk.

87. Satan's Mark Exposed 666 by Salem Kirban, Library of Congress Catalogue No 81-80654 ISBN 0-912582-36-7 an exposure of the new one world smart card system that people will carry in their hands. Several updated video presentations such as those by Texxe Mars go in far greater detail and show the actual devices under development and deployment

Newsletters

88. Media Spotlight, P O Box 290, Redmund, Western Australia, 98073- 0290, Australia (A Christian Analysis of Religious and Secular Media)
89. World Challenge , David Wilkerson New York
90. Prophecy in the News , P O Box 7000 Oklahoma City, OK 73153, USA, Tel Toll free 1-800-475-1111, (Distributors of a large range of books, video and audio tapes etc.)
91. Mc Alvany Intelligence Advisor , Donald S Mc Alvany Intellegence Advisor, P. O. Box 84904,, Phoenix, AZ,85071, U.S.A, Tel 602-252-4477, 800-525-9556,, P.O. Box 28829, Sunnyside,0132, South Africa
92. The NRI Trumpet 140 K South Peoria St. Aurora Colorado, 80014 USA Is Part of The National Research Institute (Data centre on the New Age) (Against New Age)
93. Herald of His Coming P O Box 886, Newton, 155 67114 USA
94. Omega times P O Box 561 Blenheim New Zealand (Barry Smith's son-in law a newsletter keeping people up to date with prophecy in the news)
95. Shalom Ministries P O Box 3011 Northcliff 2115 (From Israel)
96. Aida Parker Newsletter (Pty) Ltd 17 Wargrave Avenue Auckland Park, 2092 Johannesburg South Africa P O Box 91059 Tel (011) 726-6856
97. Flashpoint a periodic publication of: Living Truth Ministries, 1708 Patterson Road Austin, Texas 78733-6507 (distributers of 'The Fourth Reich of the Rich' by Des Griffin (1992))
98. Agency For Joint, Intelligence Newsletter , Willaim Cooper Camp Verde, AZ, 86322, U.S.A., Tel No (602) 567-636, Daily update, (602) 1-900-535-9800 ext 240, Computer BBS (602) 567-6725, Hotline (213) 281-8222, Orders (602) 567 6109 Research Cntr. (602) 567 6536 (Author of 'Behold a Pale Horse') William M Cooper,
99. The Roca Raport , P.O. Box 35225, Menlo Park,,0102 Tel (012) 98- 1491
100. Frontline Fellowship (Praying for Justice) P O Box 74 Newlands, 7725 South Africa
101. The Independant Christian Newsletter Dr. Hans Visser and Dr. Johan Potgieter P O Box 651 Groenkloof, 0027
102. Family Protection Scoreboard P O Box 10459 Costa Mesa California, 92627 USA Tel (714) 850-0349 Fax(714)662-3952 Special edition on Liberation Theology
103. The Christian Activist P O Box 909 Los Gatos CA 95031 (Frankey Schaefer Productions)
104. The National Citizens Action Network P O Box 10459 Costa Mesa CA 92627 USA P O Box 4016 Arcadia, 0007 RSA (Excellent video's like 'Silent Scream' 'In Search For Noah's Ark' 'Aids' 'The Lincoln Conspiracy', 'Shadow of the Sickle on the ANC' - Foreign Affairs, Missions, Satanism etc)
105. African Christian Action Tel (021) 689 4480
106. Maranatha Prophetic Alert , India by Australian Don Stanton, RSA at 110 Villiers Rd., Walmer, Port Elizabeth, 6070

Videos

107. The New World Order by Don Stanton
108. Collection of Video's and transcripts by Texxe Marrs

- 109. Collection of Video's by Don Mc Alvany
- 110. 'The New World Order' By Barry Smith' – PTW 'Through Preach the Word Ministries'
- 111. Documentary By the American Justice Federation , on ""Rehabilitation Centres'/Concentration Camps for Christians in the USA"
- 112. 'The Illuminati ' by Mike Spiller - PTW
- 113. Satan's Plan for a One World Government/Mysterious Monumnts of Beast by Texe Marrs "Through Preach the Word Ministries"

INDOCTRINATION TECHNIQUES

- 114. Christianity in Crisis Hank Hanegraaf, ISBN 1-86024-027-5, Nelson Word Ltd
- 115. Revolution or Reconciliation The Struggle For the Church in South Africa by Rachel Tingle, Christian Studies Centre London, ISBN 0-951372114
- 116. The Seduction of Christianity by Dave Hunt and McMahon, ISBN 0- 89081-441-4, Harvest House Publishers, Eugene, Oregon
- 117. Beyond Seduction by Dave Hunt and McMahon, Harvest House Publishers, Eugene, Oregon
- 118. Secret Societies and Phsycological Warfare Michael A Hoffman II
- 119. Psychological Seduction, The Failure Of Modern Psychology William Kirk Kilpatrick (Thomas Nelson Nashville Ten..)
- 120. The Agony of Decept , 1990 by the Moody Bible Institute of Chicago, local publishers, Christian Art Publishers, Vereeniging. Deals with indoctrination through the mass media via TBN etc.
- 121. To Rule the World by M. E. Beirnes, Midnight Cry Box 3686 Tequesta, Florida, 33458 The Control of mass Communications Media, Operation 76 the One World Church
- 122. KGB Today, The Hidden Hand by John Barron (Readers Digest Press)
- 123. What is Secular Humanism, James Hitchcock, Servant Books Ann Arbor
- 124. Conspirators Hierarchy, the story of the Committee of 300 Dr. John Coleman
- 125. Liberation Theology, The Church's Future Shock, Gerard Berghoff and Lester DeKoster
- 126. Psychic Warfare Fact or Fiction , John White
- 127. Satan's Angels Exposed by Salem Kirban ISBN 0-912582-32-4
- 128. The Occult Conspiracy, Michael Howard
- 129. The Evil Eye: The Unacceptable Face of Television , Guy Lyon Playfair
- 130. Psychiatry Educations Ruin - By the Citizens Commission on Human Rights, LA Calif
- 131. Lets Weigh The Evidence by Barry Burton. Published by Chick Publications, P.O. Box 662, Chino, CA 91708-0662 USA. ISBN 0-937958-17-4. Which Bible is the REAL word of God?
- 132. Die Mening-Smouse deur Ivor Benson. Burea for State Security no 63.10(608) 356 BEN. Niemand kan hoop om die Suid-Afrikaanse politiek te verstaan alvorens by die rol wat die Pors speel, verstaan alvorens by die rol wat die Pers speel, verstaan nie.
- 133. Collectivism in the Churches by Edgar C. Bundy Published by The Church League of America, 422 Prospect St. Wheaton Illinois. A devastaating indictment, fully documented! A documented account of the Political Activities of the Federal, National and World Council of Churches. To the thousands of faithful Protestant Pastos who have sacrificed buildings, prestige, and pensions rather than bow to the orders of the Soial Gospel hierachy.

134. The New Charismatics by Michael G. Moriarty. Published by Zondervan Publishing House. ISBN 0-310-53431-3. The Charismatic movement has caused quite a stir in the religious. A concerned voice responds to Dangerous New Trends such as Supernatural worship and spiritual warfare, Healing and prosperity, Signs and Wonders and many other aspects.
135. Vengeance is ours by Albert James Dager, Published by Sword Publishers, P.O. Box 290, Redmond, Washington, 98073-0290. ISBN 0-9629932-0-4. The Churches in the West have become stagnated; but there is a new militancy stirring in the breasts of Christians in response to the evils that beset society. Questions raised - Is it the Church's responsibility to take control of society and reconstruct it in accordance with God's Law?
136. The facts on Holistic Health and the New Medicine . by John Ankerberg and John Weldon. Published by Harvest House Publishers, Eugene, Oregon 97402. ISBN 0-89081-9734. The Holistic health movement has gathered many occult healing methods under its umbrella in recent years. This booklet : overviews 40 suspect practices, reveals potential dangers of various holistic treatments, question the scientific validity of the New Medicine, exposes occult influence in many holistic treatments. Giving a biblical evaluation of each practice.
137. Occult ABC by Kurt E. Koch . Published by Kregel Publications, Grand Rapids, Michigan 49501. ISBN 0-8254-3031-3. Brings to the reader an awareness of occult movements and Satan's devices.
138. Occult Theocracy by Lady Queensborough Edith Starr Miller. Order from Christian Truth and Victory Publishers, 9088 Co. Rd 11 N.W. Alexandria M.N. 56308 U.S.A. A documentation of research, giving evidence and facts covering many topics such as Religion of the Secret, Eastern Religions, Freemasons, The Illuminati. Also revealing the meaning of symbols used by all the groups.
139. Kinsey, Sex and Fraud by Judith A Reisman and Edward W. Eichel. Published by Lochinvar-Huntington House Publications, P.O.Box 53788, Lafayette, Louisiana 70505 1- 800-749-4009. ISBN 0-91-311-20-X The Indoctrination Of a People.
140. Series of lectures by the Rev Chin Reddy , ex member of the House of delegates, current chairman of the African Christian Democratic Party
141. Innocence Corrupted , by Kieron O'Brien (ex Police detective) ISBN 0-620-16594-4, Lifegrow Ministries, East London. An expose on the deception of teenagers through various means

Newsletters

142. Signpost , Signposts Publ. & Research Ctr, P.O Box 26148, Arcadia, 0007, Tel (012) 98-2680, Fax (012) 9801491
143. Report from Concerned Christians P O Box 22920 Denver Colorado, 80222 Tel (303) 777-3136 (also Kim Miller Switzerland) also Take Heed Update
144. Discernment Newsletter P O Box 129 Lapeer, Michigan, 48446-0129
145. Mainstream Publication Banner Ministries P O Box 23 Derbys, DE56 1QR UK
146. Antipas Ministries P O Box 3948 Engelwood, CO80155 USA (By Steve Shearer exposing end time doctrines of Demons)
147. The Berean Call P O Box 7019, Bend Oregon USA (by Dave Hunt)
148. Salt Shakers Tel 841014 (A/H) Jude 3 Contend for the faith that was once for all entrusted to the saints

Videos

149. Collection of transcripts and videos by Jewish Messianic Scholar Jacov Prasch
150. Massive Collection of videos, tapes and pamphlets by Preach the Word Ministries , Underberg, Natal

NEW AGE SECULAR HUMANISM

151. Inside the new Age Nightmare , Randall N Baer, Huntington House Inc. Louisiana, ISBN 0-910311-58-7, A Former Top New Leader exposes the secret plans and subtle deceptions of the New Age movement. Baer died in a car crash that had all the makings of sabotage two weeks after the book was released.
152. The Hidden Dangers of the Rainbow Life Bookroom, P O box 600 Edenvale 1610, Tel (011) 452-6920-3 Fax 456 4852
153. Understanding the New Age Movement , Dave Hunt, (Huntington Press)
154. New Age Bible Versions by G.A. Riplinger. Compiled after a 6 year exhaustive stude of new bible versions, their underlying Greek manuscripts, editions, editors and their hidden alliance with the New Age Movement's One World Religion.
155. Ancient Empires of the New Age, Paul DeParrie / Mary Pride, Crossway Books, Illinois, ISBN 0-89107-530-5
156. Video Tapes
157. New Age - (One world religion)
158. Collection of tapes by Texxe Marrs
159. Large collection of videos by Preach the Word Ministries, Underberg, Natal

VATICAN

160. " The Ceremony of Induction and extreme oath of the Jesuits " (Library of congress Catalog Card *66-43354)
161. The Secret History of the Jesuits by Edmund Paris
162. The Vatican Billions by Avro Manhattan
163. The Vatican Moscow Washington Alliance by Avro Manhattan 1982
164. All Roads Lead to Rome by Michael de Semiyen
165. The Two Headed Dragon of Africa From Sword Distributors, P O Box 72656, Lynwood Ridge, 0040, South Africa, Tel (011) 486 3361
166. A Woman Rides the Beast by Dave Hunt From Bet-El (see Below)
167. The Pope's Armada by Gordon Urquhart
168. In God's Name David Yallop Corgi ISBN 0552126403, 1984
169. The Two Babylons by Rev Alexander Hislop A&C Black Ltd England
170. The Engineer Corps of Hell' by Edwin A. Sherman, Pg 118 1883
171. The Alberto Series Alberto Riviera (Sword Distributors)
172. Revolution or Reconciliation by Rachel Tingle
173. Smokescreens by Jack T Chick
174. Foxe's Book of Martyrs by John Foxe
175. The Broken Cross by Piers Compton
176. Vicars of Christ: Dark Side of the Papacy Peter De Rosa Phd

177. Gods Banker by Rupert Cornwell. The Life and Death of Roberto Calvi. A thriller, an entfinancial malpractice in high places. Political intrigue, Secret Societies. It is of particular interest to bankers and students concerned with international banking. Published by Unwin Paperbacks, 40 Museum Street, London WC1A 1LU, UK. ISBN 0-04-332099-6
178. Babylon Mystery Religion by Ralph Edward Woodrow P.O. Box 124 Riverside, CA 92500124. ISBN 0-916938-12-3. A detiled Biblical and historical account of how, when, why and where ancient paganism was mixed with Christianity.

Hidden Secrets of the Eastern Star

The Eastern Star exposed

In this important book, Dr. Cathy Burns methodically documents the fact that both Masonry and the Eastern Star are occultic organizations.

You will learn secret passwords, symbols, colors, flowers, gems, and a GODDESS connection. Also included is a special chapter on the Rainbow Girls that contains information every parent needs to know.

The book includes 1,483 footnotes, many of which are from Eastern Star and Masonic sources. After reading this book, you will know the answers to questions like:

- **Is it a secret society?**
- **What is the Cabalistic Motto?**
- **WHO is represented by the star?**
- **Is there a Masonic connection?**

Table of Contents

1. A Brief History of the Eastern Star
2. The Masonic Connection
3. The Eastern Star and Christianity
4. His Star in the East
5. The Pentagram
6. A Look at Baphomet
7. Symbolism of the Eastern Star
8. More Eastern Star Symbolism
9. Gavel, Clasped Hands and Veil
10. Eastern Star Goddesses
11. What is the Cabalistic Motto?
12. Is Death a Victor?
13. Secrecy and the Eastern Star
14. The Four Elements
15. A Look at the Rainbow Girls

Author: [Dr. Cathy Burns](#)

ISBN: 0005021812

Price: \$15.95 US

Pages: 496 - Paperback

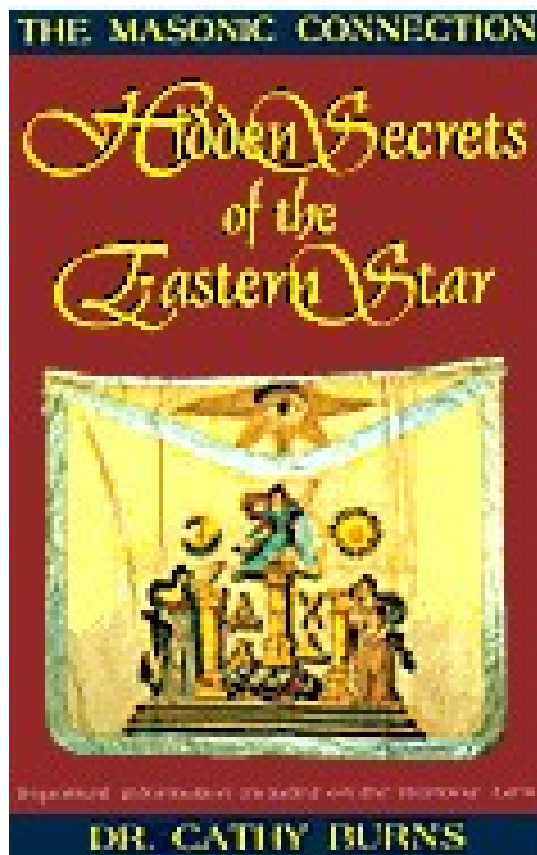

CONTACT DETAILS

Mobile: - +61 4525 7899 2

Email: - izak@izak.co.za

Web page: - <https://izak.co.za/>

Linkedin: - <https://www.linkedin.com/in/izak-labuschagne-12550818/>

Currently living in Queensland Australia (2023)

Automated Table of Contents

TABLE OF CONTENTS	2
INTRODUCTION OF SPEAKER.....	5
OVERVIEW	6
CHAPTER ONE	7
JUDGING FREEMASONRY	7
DEFINITION OF FREEMASONRY.....	7
IS FREEMASONRY FOUNDED ON THE BIBLE?.....	7
<i>Opening understanding / Closing understanding</i>	9
IS FREEMASONRY A SECRET SOCIETY?.....	9
MASONIC OATHS.....	11
ARE THE DETAILS IN THE UPPER DEGREES HIDDEN FROM FREEMASONS OF LOWER DEGREES.....	13
<i>Lower degree Masons are deliberately deceived by those of the upper degrees</i>	13
<i>What is this light really?</i>	13
CHAPTER TWO.....	15
IS FREEMASONRY A RELIGION	15
<i>Definition of religion</i>	15
<i>Masonry even has a way of Salvation</i>	16
<i>The religion of Freemasonry propagates new birth</i>	17
SO THEN WHAT RELIGION IS FREEMASONRY	18
<i>Cabalism</i>	18
<i>Nimrod</i>	19
<i>Sun Worship</i>	19
<i>Meaning of the Masonic God Jahbulon</i>	19
<i>Solomon and Hiram Abif or rather Hiram King of Tyre</i>	20
WHAT IS CABALISM.....	21
WHAT DOES THE BIBLE SAY ABOUT CABALISM	22
<i>Overview diagram</i>	22
DANGERS OF CABALISM.....	22
<i>3rd degree Horus and Isis</i>	23
<i>Curses of the Bible</i>	23
GRADUAL ROAD TO CABALISM.....	25
SECULAR HUMANISM.....	25
THE DANGERS OF FREEMASONRY	25
<i>MASONIC ILLUMINATION - LUCIFERIAN</i>	26
<i>MASONIC GOD - LUCIFER</i>	27
<i>THE WITCHCRAFT CONNECTION</i>	29
<i>SIMILARITIES BETWEEN FREEMASONRY, THE OCCULT AND SATANISM</i>	30
CHAPTER THREE	34
WHERE DOES MASONRY COME FROM	34

<i>MYSTERY BABYLON</i>	34
<i>The Knights Templar</i>	36
<i>Hospitalers</i>	37
<i>Jesuits Ignatius De layola</i>	37
<i>Jesuit Oath</i>	38
METHOD OF INFITRATION.....	40
CHAPTER FOUR	43
THE POLITICAL INTERCONNECTIONS	43
<i>The Palladium</i>	43
<i>Illuminati</i>	43
<i>One Dollar Bill</i>	44
TODAY'S NETWORK.....	46
<i>The Lucis (Lucifer) Trust</i>	46
<i>A New Age Network</i>	46
<i>The Vatican</i>	47
<i>The Club of Rome</i>	49
<i>The Provisional World Government</i>	49
<i>The Tavistock Institite – Workshop</i>	50
<i>The Council on Foreign Relations</i>	50
<i>The Royal Institute of International Affairs</i>	50
<i>The Bilderbergers</i>	50
<i>The Tri Lateral Commission</i>	50
<i>The Mafia Yakuza and Triads</i>	50
<i>Multinationals</i>	50
<i>The Committee of 300</i>	50
<i>The UN</i>	50
<i>Conditionality Treaties</i>	50
<i>The Rio Summit</i>	50
<i>The Iron Mountain Report</i>	50
RELATED ORGANIZATIONS TO FREEMASONRY	52
CHAPTER FIVE	53
FREEMASONRY AND LITIGATION	53
<i>Judge President</i>	65
<i>RE: LABUSCHAGNE V D WARNE AND ASSOCIATES (PTY) LTD - CASE NO 5447/96</i>	65
<i>Secret Societies and organizations Freemasonry</i>	66
<i>Unethical conduct by officers of court</i>	67
CHAPER SIX	71
BRAINWASHING ECHNIQUES	71
<i>Training Manual No. TM-SW7905.1</i>	72
MIND CONTROL APOTHEOSIS	77
NOTICES OF COMMISSION	78
CHAPTER SEVEN	79
SUMMARY	79
WHAT TO DO IF I AM A CHRISTIAN?	79
COVENANT OATH OF GOD AND OF MAN.....	81
THE ARMOUR OF GOD.....	82

OTHER POINTS O CONSIDER ARE:	82
GODS PLAN OF SALVATION.....	83
<i>The Bible says there is only one way to Heaven</i>	83
MORE SCRIPTURES FOR FREEMASONS	86
PRINCIPALITIES AND POWERS	86
OATHS	86
SECRECY.....	86
LIGHT.....	87
GODS NAME.....	88
HIRAM ABIF KING OF TYRE (ITHOBALUS 11).....	88
BOAZ.....	90
KINSMAN'S REDEMPTION BOAZ.....	90
CORNER STONE	93
<i>Parable of Vinyard_</i>	93
<i>String.....</i>	96
NIMROD	100
SOLOMON.....	102
DECEPTION	102
WISDOM.....	106
NOT WORKS -GRACE.....	107
SALVATION THROUGH CHRIST ALONE.....	108
BE BORN AGAIN	108
LACK OF KNOWLEDGE	109
IDOLS - OTHER GODS	109
OTHER PRACTICES.....	109
GODS JUDGMENT	110
3 - 4 GENERATIONS	111
BURN IT	111
CHASTISING.....	111
BE SEPRATED	112
GATES OF BRASS.....	113
DEMIT TO THE LODGE	114
BIBLIOGRAPHY	116
MASONIC	116
NEWSLETTERS.....	117
VIDEO TAPES	118
NEW WORLD ORDER	118
NEWSLETTERS.....	120
VIDEOS.....	120
INDOCTRINATION TECHNIQUES.....	121
NEWSLETTERS.....	122
VIDEOS.....	122
NEW AGE SECULAR HUMANISM.....	123
VATICAN	123
CONTACT DETAILS.....	125